

# WORLD BLOCK



TM

THE WORLD'S #1 BLOCK FORM COMPANY

## LANDSCAPE BLOCK FORM

■ PAGE 2

## MID-SIZE BLOCK FORM

■ PAGE 16

## V-INTERLOCK BLOCK FORM

■ PAGE 26

## KNOB STYLE BLOCK FORM

■ PAGE 32

## PARKING CURB FORM

■ PAGE 36

## PAVER MOLD

■ PAGE 38

## LINERS

■ PAGE 40

## U-ANCHORS

■ PAGE 47



**APC Concrete  
Breckenridge, CO**

It can be said that World Block Landscape Block Forms are the building blocks of this country. Since their introduction, these forms have been responsible for building thousands of walls around the nation. Why are they so popular? Simplicity and functionality. As with all World Block forms, the Landscape Block

Form was created to get the job done quickly and with minimal headache. This one form performs many tasks so you don't have to waste money on needless forms.

The basic form creates straight edge blocks for straight walls. Add the tapered end inserts and now your blocks can create curved walls with up to a

14 foot radius (measured to the back of the block). And by simply bolting the half block divider into your form you can pour two half blocks at one time all with the same form.

The form is built with two "L" shaped halves that lock together with heavy-duty, over-center locking clamps for easy set-up and stripping. The blocks are poured

face down with the liner on the bottom of the form to create the large rock face.

This design allows you to get many pours per day from one form. After your first pour has set, strip the form and leave the block to cure face down on its liner. Set the form up around a second liner and pour again. Depending on your mixture you can get two or three,





“  
Landscape  
blocks allow  
you to control  
your terrain.  
Turn steep  
hills into  
usable space.”

### ■ 24" X 24" X 48" FULL BLOCK FORM

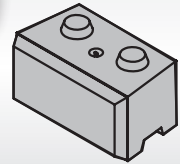

■ Sku Number: **LS-1010S**  
Form Weight: **380 lbs**  
Block Weight: **2,400 lbs**  
Volume: **16.00 ft<sup>2</sup>**

**\$1,222.00**

### ■ TAPERED END BLOCKOUTS

(PAIR) • (WORKS WITH STANDARD, SLOPED, AND CORNER FORMS)

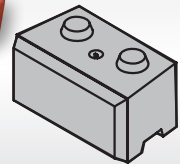

■ Sku Number: **LS-1010T**  
Form Weight: **65 lbs**  
Block Weight: **2,250 lbs**  
Volume: **15.00 ft<sup>2</sup>**

**\$407.00**

### ■ 24" X 48" X 4" LANDSCAPE LINER

■ Sku Number: **FL-LDS003**  
Form Weight: **60 lbs**

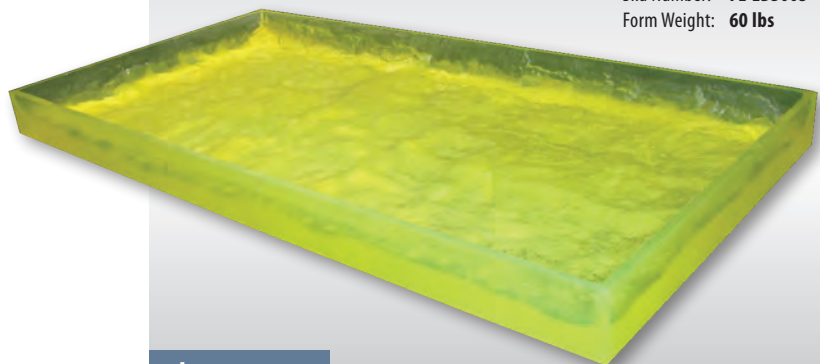

**\$472.00**

even four blocks per day from one form.

The notch on the bottom of the block creates enough "slop" to allow the blocks to make curved walls. The notch pan comes bolted in place to allow the blocks to terrace back two inches on every course. The notch pan can be easily replaced if you want your blocks to lie flush.

# LANDSCAPE BLOCK FORMS

Half blocks are used when finishing off the end of a wall when laid with a running bond. A divider will bolt into either a standard or corner form to create half blocks. When using a standard form, two liners are placed one on either side of the divider so you can create two half blocks in one pour. The tapered divider creates half blocks with tapered sides for laying curved walls. The straight divider creates straight sided blocks.

■ HALF BLOCK  
**STRAIGHT DIVIDER**  
WORKS WITH STANDARD AND CORNER FORMS

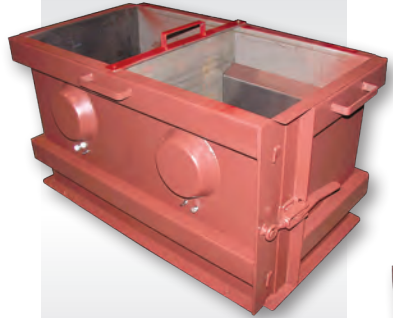

■ Sku Number: **LS-1020S**  
Form Weight: **50 lbs**  
Block Weight: **1,350 lbs**  
Volume: **9.00 ft<sup>2</sup>**

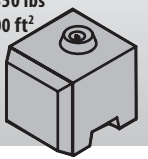

**\$290.00**

■ HALF BLOCK  
**TAPERED DIVIDER**  
WORKS WITH STANDARD AND CORNER FORMS

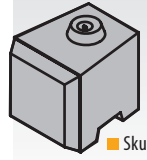

■ Sku Number: **LS-1020T**  
Form Weight: **65 lbs**  
Block Weight: **1,200 lbs**  
Volume: **8.00 ft<sup>2</sup>**



**\$407.00**

■ 24" X 24" X 4"  
**LANDSCAPE HALF LINER**  
WORKS WITH STANDARD AND CORNER FORMS

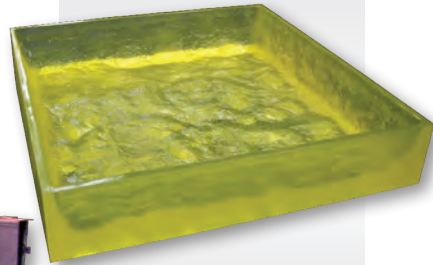

■ Sku Number: **FL-LDS006**  
Form Weight: **25 lbs**

**\$290.00**



“ Half blocks help maintain your running-bond pattern. ”





**DLO Excavating  
Cottage Grove, MN**

## THE PROBLEM:

Landscape blocks step back 2 inches on every course. When using corner blocks, they also step in 2 inches to adjust for the wall running in the other direction. If only one corner block is used, this offset is unnoticeable and easy to deal with. When using two corners, as shown below, the wall gets squeezed 4 inches on each course.

## THE SOLUTION:

Key blocks are 4 inches shorter than the standard block - 44 inches versus 48. Use one additional key block for each successive course feeling the squeeze. For example, on the first course no key blocks are required. The second course needs one key block, the third course needs two, the fourth course needs three, and so on. At 12 courses the wall is being squeezed 48 inches and does not require a key block - simply start the pattern over again.

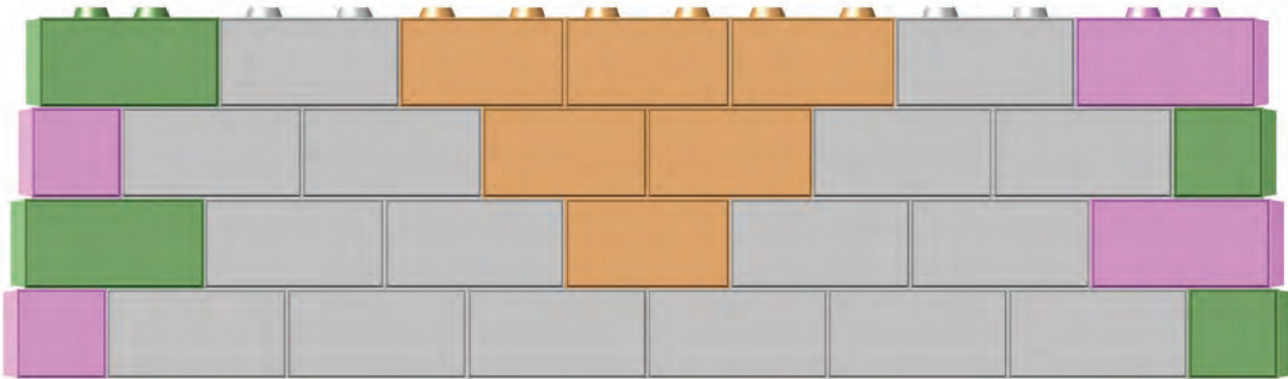

### KEY BLOCK BLOCKOUT

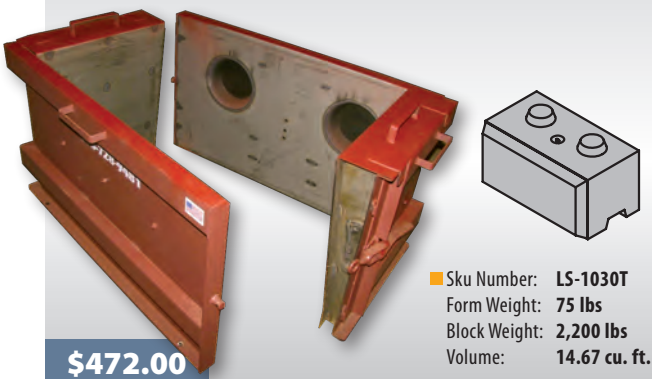

■ Sku Number: **LS-1030T**  
 Form Weight: **75 lbs**  
 Block Weight: **2,200 lbs**  
 Volume: **14.67 cu. ft.**

**\$472.00**

### 24 X 44 X 4 KEY BLOCK LINER

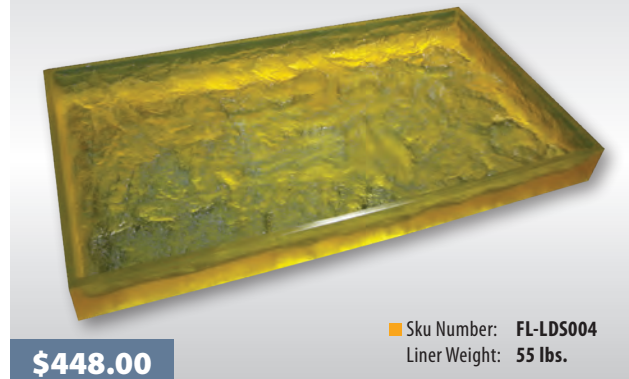

■ Sku Number: **FL-LDS004**  
 Liner Weight: **55 lbs.**

**\$448.00**

**Call Now 218-728-9481**

## LANDSCAPE BLOCK FORMS

Corner blocks are used when you need to turn a 90 degree outside corner or when you simply want to finish off the end of a wall with a rock face. This form will create both a left and right facing block by just flipping the liner to the other side. The form is used with an "L" shaped liner that sits in the bottom and up one side of the form.



■ 24" X 28" X 24" X 52" X 4"  
**CORNER LINER**

■ Sku Number: **FL-LDS121**  
Liner Weight: **75 lbs.**

**\$760.00**

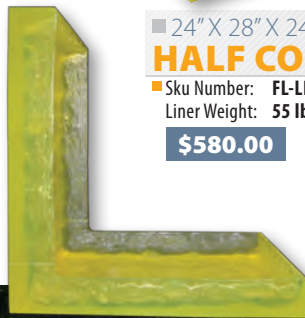

■ 24" X 28" X 24" X 28" X 4"  
**HALF CORNER LINER**

■ Sku Number: **FL-LDS122**  
Liner Weight: **55 lbs.**

**\$580.00**

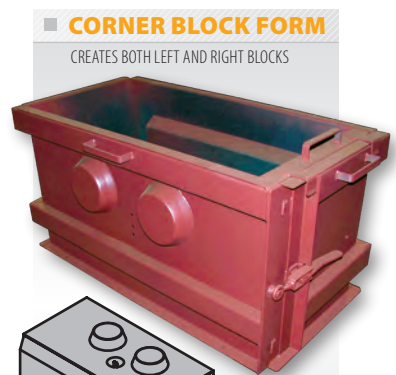

■ **CORNER BLOCK FORM**

CREATES BOTH LEFT AND RIGHT BLOCKS

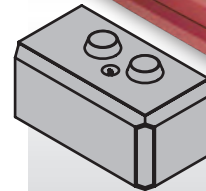

■ Sku Number: **LS-1040S**  
Form Weight: **405 lbs**  
Block Weight: **2,850 lbs.**  
Volume: **19 cu. ft.**

**\$1,457.00**



**Corner Blocks  
made using the  
Corner Shim.**

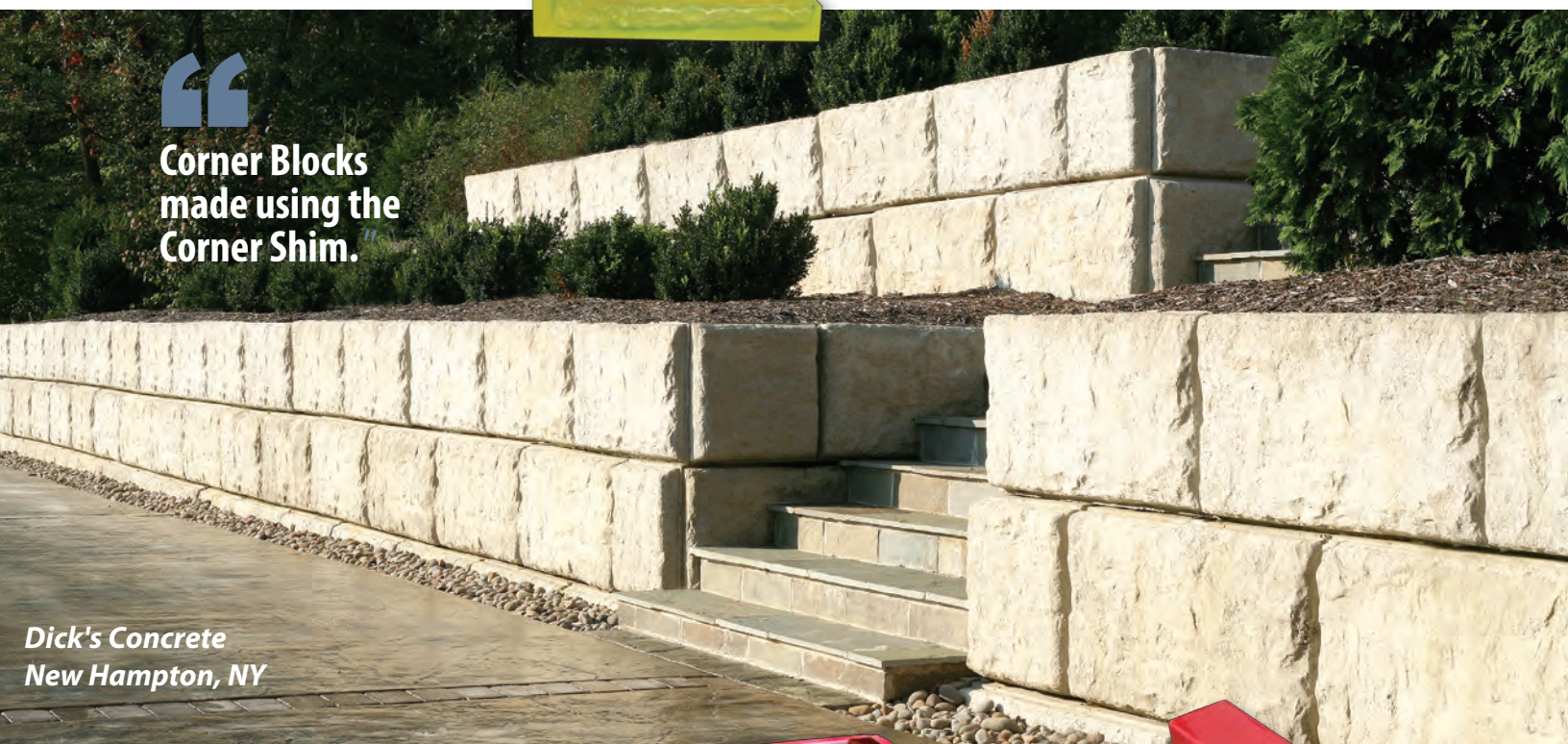

*Dick's Concrete  
New Hampton, NY*

With this handy little device there is no need to buy a corner liner for your corner forms. This piece fits into the corner of a corner block form allowing you to use a standard 24 x 48 liner and a 24 x 24 liner to make a corner block.



■ 4" X 4"  
**CORNER SHIM**

■ Sku Number: **LS-SHIM**  
Liner Weight: **12 lbs.**

**\$62.00**



# CORNER BLOCK INSTALLATION



Alaska Concrete  
Juneau, AK

Why can't I use a regular form to make a corner?

The Landscape block was

designed to have a 24" x 48" footprint. The 4" depth of the liner makes the block actually 28" deep. The corner form must compensate for this 4" in the other direction.



This wall at 24 feet high shows an impressive use of corner blocks."

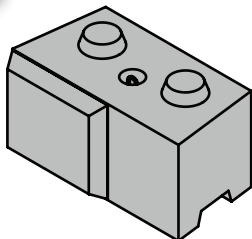

24" X 20" X 4"

## INSIDE CORNER LINER

■ Sku Number: FL-LDS007  
Liner Weight: 30 lbs.

\$270.00

24" X 28" X 4"

## INSIDE CORNER BLOCKOUT

■ Sku Number: LS-1041  
Liner Weight: 42 lbs.

\$168.00



OUTSIDE CORNER

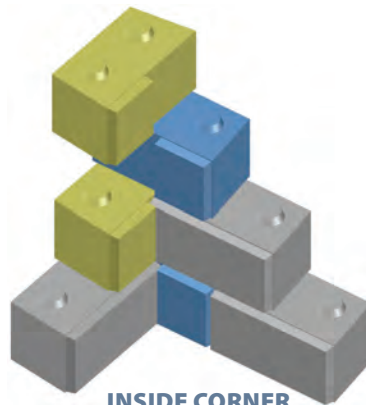

INSIDE CORNER

Creating corners, while simple, has its own set of rules.

There are two types of corners you will encounter: Outside and Inside.

With corners, each wall's running bond will be off by 2" on every row. This is an aesthetic matter and not a structural one and can easily be corrected using key blocks.

### 1 THE OUTSIDE CORNER

The outside corner is made by alternating Left and Right Outside Corner Blocks on each successive course. Remember that each Corner Block will be placed back 2 inches in both directions to account for the wall's setback.

### 2 THE INSIDE CORNER.

To make an inside corner, you'll need an Inside Corner Blockout and an Inside Corner Liner which fit inside a standard form. Because of the geometry of inside corners, the inside knob of each corner block must be blocked out. To compensate, use construction adhesive to lock the block in place. Overlap one Left or Right Inside Corner Block successively on each course to make the corner.

## ■ LANDSCAPE BLOCK FORMS

**S**o, you've reached the top of your wall. Now what do you do? Top caps may be inappropriate for certain applications so we have developed recess blockouts to help top off your walls.

A recess blockout creates a 6 inch recess in the top of the block. If you are backfilling behind your wall, this void allows you to fill up and over the top of your wall. It is deep enough for any landscaping to take root.

The recess blockouts bolt directly onto your existing form. If you are using a form without tapered ends you will need a Straight End blockout. If you have the tapered ends, get the Tapered End blockout.

Half block dividers are needed for your forms when you are using the recess blockouts. The half block dividers are cut out to fit around the blockout after it is bolted in place.

You can also recess a sloped end block or a corner block. In both instances the recess stops before the end of the block. The recess blockout for sloped end works with the sloped end blockout. The recess blockout for corner works in the corner block form. Each require a separate left and right hand blockout



### ■ FULL RECESS BLOCKOUT STRAIGHT ENDS

■ Sku Number: **LS-R1010S**  
 Form Weight: **80 lbs**  
 Block Weight: **2,200 lbs**  
 Volume: **14.67 cu. ft.**

**\$525.00**

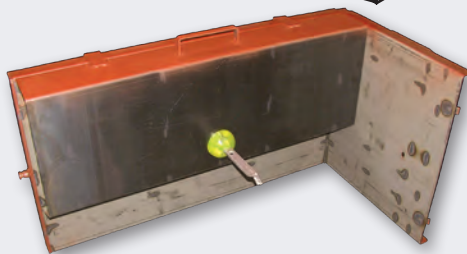
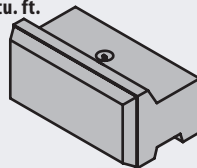

### ■ FULL RECESS BLOCKOUT TAPERED ENDS

■ Sku Number: **LS-R1010T**  
 Form Weight: **80 lbs**  
 Block Weight: **2,100 lbs**  
 Volume: **14.00 cu. ft.**

**\$525.00**

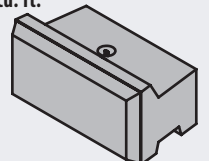

**If the top of your wall is under your feet, you may want to use recessed blocks."**

### ■ RECESS BLOCKOUT FOR SLOPED END

Separate Left and Right block-out required

■ Sku Number Left: **LS-R1070L**  
 Sku Number Right: **LS-R1070R**  
 Form Weight: **80 lbs**  
 Block Weight: **1,950 lbs**  
 Volume: **6.50 cu. ft.**

**\$407.00**

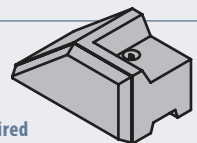

Left block form shown



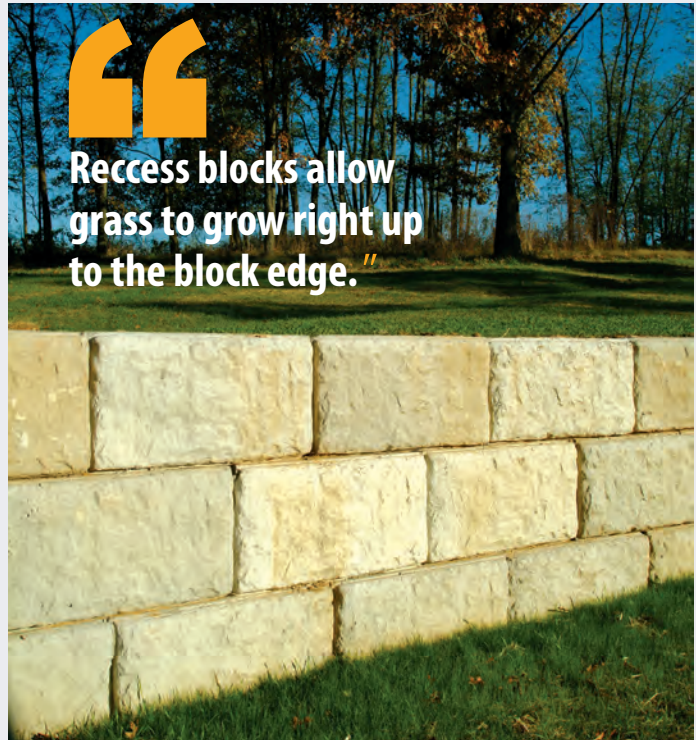

Recess blocks allow grass to grow right up to the block edge."

**■ HALF BLOCK STRAIGHT RECESSED DIVIDER**

■ Sku Number: **LS-R1020S**  
 Form Weight: **45 lbs**  
 Block Weight: **1,050 lbs**  
 Volume: **7.00 cu. ft.**

**\$290.00**

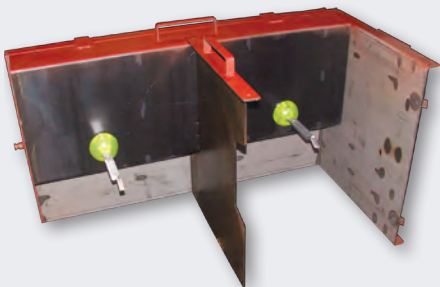
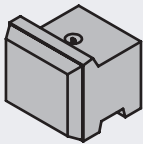

**■ HALF BLOCK TAPERED RECESSED DIVIDER**

■ Sku Number: **LS-R1020T**  
 Form Weight: **55 lbs**  
 Block Weight: **975 lbs**  
 Volume: **6.50 cu. ft.**

**\$407.00**

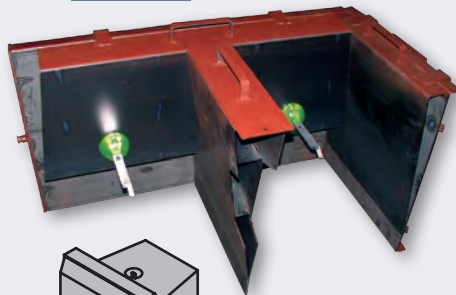
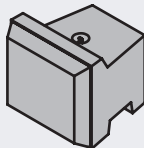

Why buy extra forms when you don't have to?  
 These blockouts fit into your existing forms.

**■ RECESS BLOCKOUT FOR CORNER STRAIGHT END**

■ Sku Number Left: **LS-R1040SL**  
 Sku Number Right: **LS-R1040SR**  
 Form Weight: **120 lbs**  
 Block Weight: **2,400 lbs**  
 Volume: **16.00 cu. ft.**

**\$525.00**

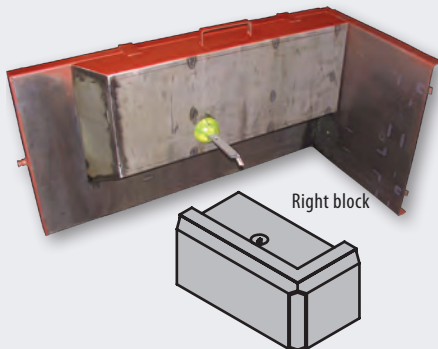

**■ RECESS BLOCKOUT FOR CORNER TAPERED END**

■ Sku Number Left: **LS-R1040TL**  
 Sku Number Right: **LS-R1040TR**  
 Form Weight: **120 lbs**  
 Block Weight: **2,400 lbs**  
 Volume: **16.00 cu. ft.**

**\$525.00**

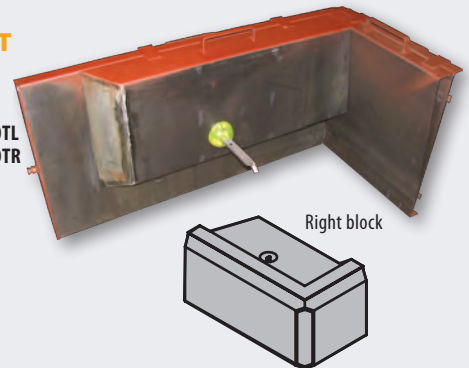

**Call Now 218-728-9481**

## LANDSCAPE BLOCK FORMS

### TOP CAP FORM

WORKS WITH STANDARD AND CORNER FORMS



■ Sku Number: **LS-1050T**  
 Form Weight: **200 lbs**  
 Block Weight: **1,125 lbs**  
 Volume: **7.50 ft<sup>2</sup>**

**\$642.00**

Poured upside-down, the Top Cap Form creates a block 8" high, 48" wide at the front and 42" wide at the back. The stone face liners fit into the front and back of the form. When the blocks are laid head to toe they will lie straight. Laid head to head they will curve back. Laid toe to toe they will curve in. The liners have open ends so they will butt seamlessly against the adjoining block face.

■ 8 X 48 X 4

### LANDSCAPE TOP CAP LINER

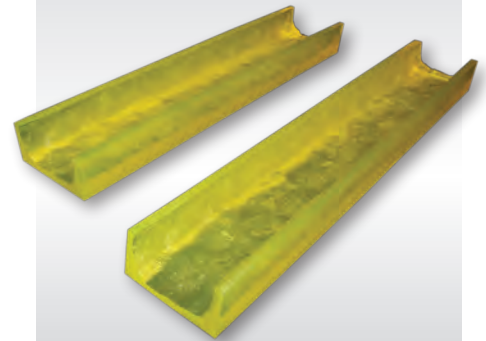

■ Sku Number: **FL-LDS302**  
 Form Weight: **45 lbs**

**\$285.00**

“Top Caps give your wall a clean, finished look.”



How do I handle the Top Cap and Step blocks?

There is no single way to best

handle these blocks. Placing a lift point will mar the surface, but can be grouted over. Nuts can be cast in place for use with eye-bolts. Most people simply use straps.

*Theut Products  
 Romeo, MI*

The step form creates one step 30" deep x 48" wide with a 7" high riser and a stone face on three sides. The one piece liner is hinged in the corners to wrap around the front and two sides. To create stairs simply stack one on top of another allowing for desired tread depth.

### STEP FORM

■ Sku Number: **LS-STEP**  
 Form Weight: **210 lbs**  
 Block Weight: **875 lbs**  
 Volume: **5.83 ft<sup>2</sup>**

**\$461.00**

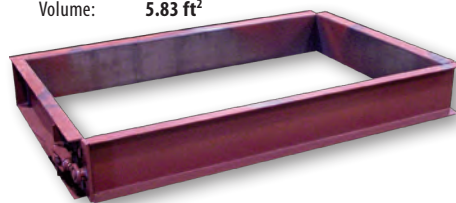

■ 7 X 30 X 7 X 48

### LANDSCAPE STEP LINER

■ Sku Number: **FL-LDS301**  
 Form Weight: **40 lbs**

**\$370.00**



**■ HALF SLOPED END BLOCKOUT**  
CREATES BOTH LEFT AND RIGHT SLOPED BLOCKS

■ Sku Number: **LS-1070H** **\$530.00**  
Form Weight: **80 lbs**  
Block Weight: **2,175 lbs.**  
Volume: **14.50 cu. ft.**



■ **24" X 48" X 4"**  
**HALF SLOPED LINER**  
SEPARATE LEFT AND RIGHT LINERS REQUIRED



**RIGHT**  
■ Sku Number: **FL-LDS201**  
Liner Weight: **55 lbs**  
**\$472.00**



**LEFT**  
■ Sku Number: **FL-LDS202**  
Liner Weight: **55 lbs**  
**\$472.00**

Sloped end Blocks are used to transition from one course of blocks to another. This blockout simply sets into the top corner of your landscape block form. The sloped liner fits right up against it. While only one blockout is needed for both left and right sloped block, separate left and right liners are required.

**■ FULL SLOPED END BLOCKOUT**  
CREATES BOTH LEFT AND RIGHT SLOPED BLOCKS

■ Sku Number: **LS-1070F** **\$611.00**  
Form Weight: **80 lbs**  
Block Weight: **1,545 lbs.**  
Volume: **10.30 cu. ft.**



■ **24" X 48" X 4"**  
**FULL SLOPED LINER**  
SEPARATE LEFT AND RIGHT LINERS REQUIRED



**RIGHT**  
■ Sku Number: **FL-LDS203**  
Liner Weight: **55 lbs**  
**\$472.00**



**LEFT**  
■ Sku Number: **FL-LDS204**  
Liner Weight: **55 lbs**  
**\$472.00**

“ Sloped ends move blocks gradually from course to course. ”



**Call Now 218-728-9481**

# LANDSCAPE BLOCK FORMS

**S**ometimes you want to make things a little more interesting. On purpose.

Here are the Landscape Half-High blocks. Designed to let you make a truly random stack wall without all the complications that come with random shaped blocks.

The Half-High blocks are exactly that: half as high as a standard block - or 12 inches tall.

You can stack 2 half high blocks on top of each other and they will be exactly the same height as a standard block. With a little creativity and foresight, you can stack an infinitely random pattern wall with only 4 different block sizes. That's right:

- **2 forms**
- **4 blocks**
- **infinite possibilities**

12" X 24" X 48"  
**HALF-HIGH FORM**

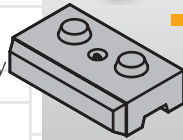

■ Sku Number: **LS-3010S**  
Form Weight: **260 lbs**  
Block Weight: **1,275 lbs.**  
Volume: **8.5 cu. ft.**

**\$1,049.00**

**HALF-HIGH TAPERED END BLOCKOUTS**  
(PAIR) • (WORKS WITH STANDARD, SLOPED, AND CORNER FORMS)

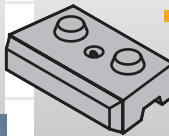

■ Sku Number: **LS-3010T**  
Form Weight: **40 lbs**  
Block Weight: **1,200 lbs.**  
Volume: **8 cu. ft.**

**\$224.00**

12" X 48" X 4"  
**LANDSCAPE HALF-HIGH FORM LINER**

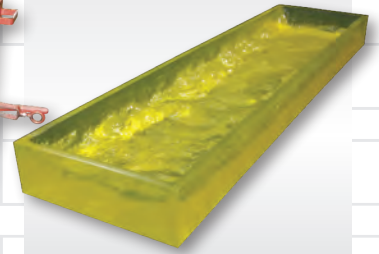

■ Sku Number: **FL-LDS014**  
Form Weight: **35 lbs**

**\$290.00**

**HALF-HIGH STRAIGHT DIVIDER**

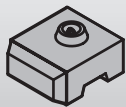
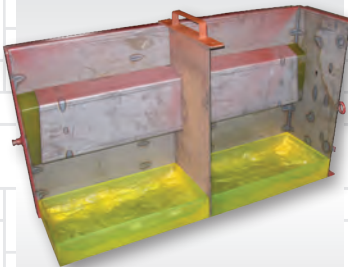

■ Sku Number: **LS-3020S**  
Form Weight: **23 lbs**  
Block Weight: **675 lbs.**  
Volume: **4.5 cu. ft.**

**\$172.00**

**HALF-HIGH TAPERED DIVIDER**

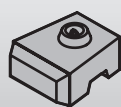
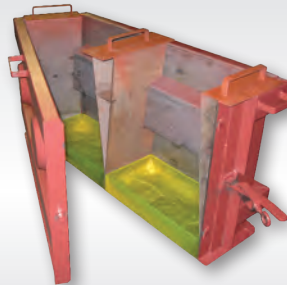

■ Sku Number: **LS-3020T**  
Form Weight: **35 lbs**  
Block Weight: **600 lbs.**  
Volume: **4 cu. ft.**

**\$224.00**

12" X 24" X 4"  
**LANDSCAPE HALF-HIGH HALF LINER**

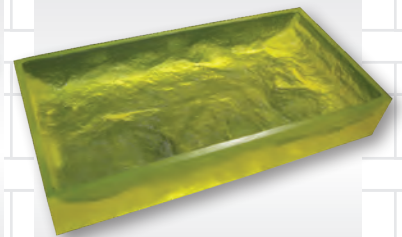

■ Sku Number: **FL-LDS017**  
Form Weight: **20 lbs**

**\$199.00**

**HALF-HIGH CORNER FORM**  
CREATES BOTH LEFT AND RIGHT BLOCKS

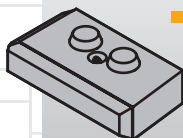

■ Sku Number: **LS-3040S**  
Form Weight: **290 lbs**  
Block Weight: **1,350 lbs.**  
Volume: **9 cu. ft.**

**\$1,242.00**

12" X 28" X 12" X 52" X 4"  
**LANDSCAPE HALF-HIGH CORNER LINER**  
CREATES BOTH LEFT AND RIGHT BLOCKS

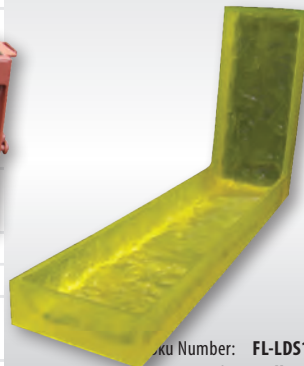

■ Sku Number: **FL-LDS123**  
Form Weight: **45 lbs**

**\$545.00**

12" X 28" X 12" X 28" X 4"  
**LANDSCAPE HALF-HIGH HALF CORNER LINER**  
CREATES BOTH LEFT AND RIGHT BLOCKS

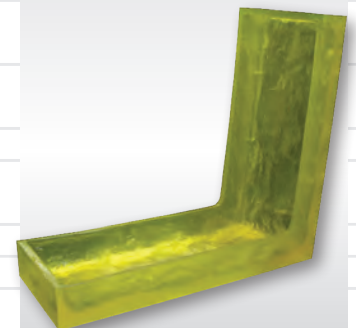

■ Sku Number: **FL-LDS124**  
Form Weight: **45 lbs**

**\$398.00**



Landscape Blocks have been engineered to hold back a lot of earth.



The rough hewn stone face adds architectural interest to any setting.



The large scale of the Landscape Block is a natural fit for industrial and commercial uses.



**American Concrete Products  
Auburn, ME**

With its size, scale and good looks the Landscape Block will work almost anywhere.

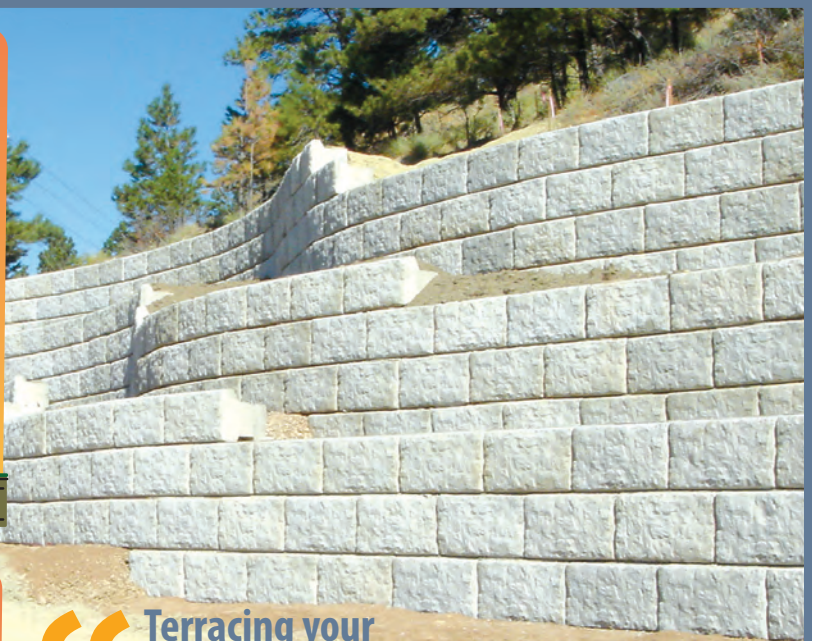
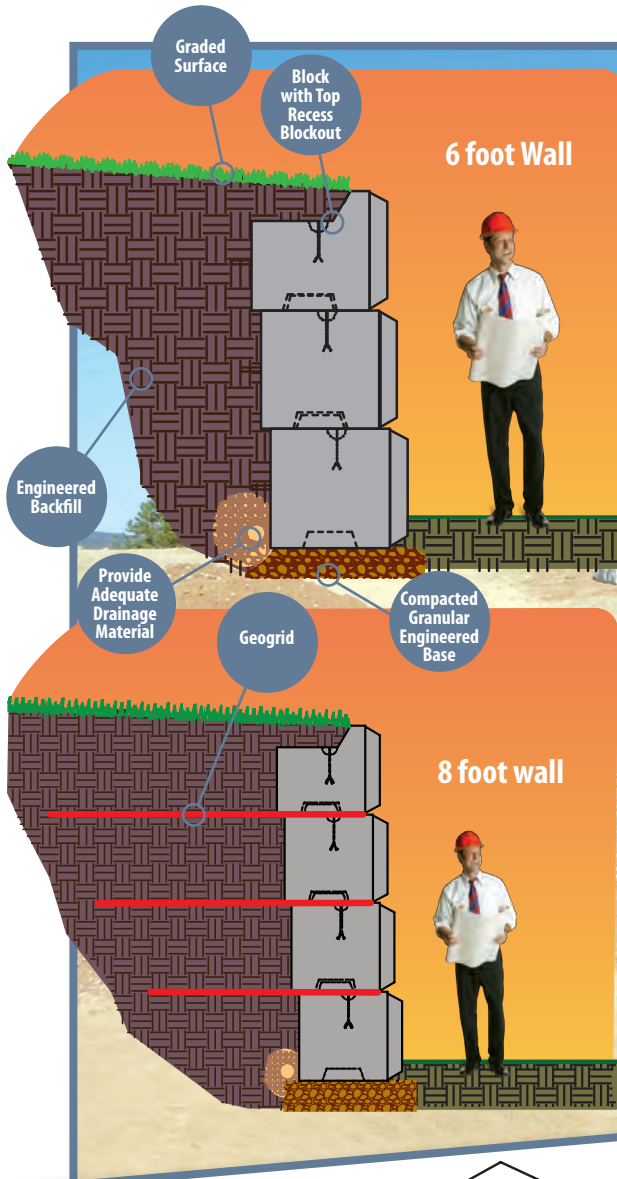

“Terracing your landscape wall can minimize the need for geogrid.”

## How High Can I Go?

Your landscape blocks can easily make a wall up to 6 feet high (3 courses). Once you get past that height you will want to use site specific engineering that will specify the geogrid layout and installation. We offer general landscape engineering and specifications on our website at [www.worldblock.com](http://www.worldblock.com).

While geogrid is typically

used in walls that go roughly straight up, if you have the space, terracing your walls is a dramatic way to reach desired heights with little or no need for soil reinforcement. Terracing is accomplished by creating a wall, backfilling, measuring back a certain distance and then building another wall. You will still want to talk to an engineer for local specifications and proper permitting.

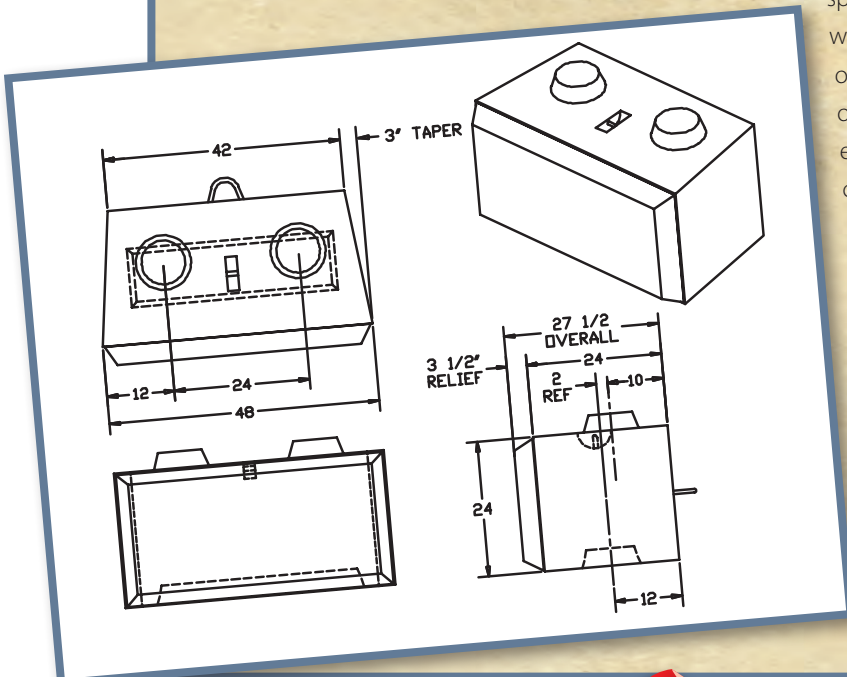

## Install-Info

Our complete installation and engineering manual includes construction details, installation guides and product

specifications. It is available for free and immediate download on our website:

[www.worldblock.com](http://www.worldblock.com)



## BASE BLOCK

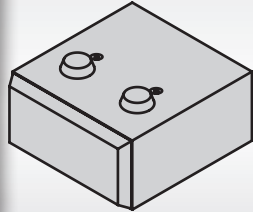

■ Sku Number: **LS-2010S**  
 Form Weight: **800 lbs**  
 Block Weight: **5,100 lbs**  
 Volume: **34.00 cu. ft.**

**\$2,443.00**

## BASE BLOCK

Tapered End  
 Blockouts  
 (Pair)

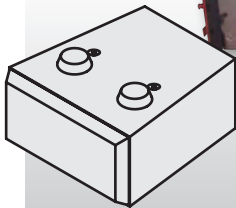
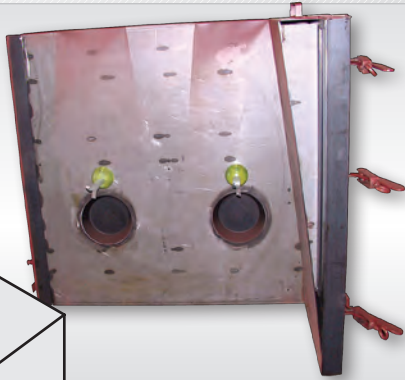

■ Sku Number: **LS-2010T**  
 Form Weight: **140 lbs**  
 Block Weight: **4,500 lbs**  
 Volume: **30.00 cu. ft.**

**\$632.00**

## BASE BLOCK

Tapered Half Block Divider

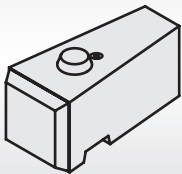
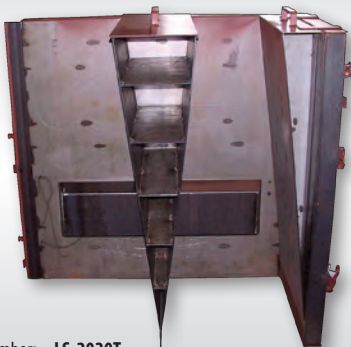

■ Sku Number: **LS-2020T**  
 Form Weight: **120 lbs**  
 Block Weight: **2,430 lbs**  
 Volume: **16.20 cu. ft.**

**\$632.00**

## Do you want to go higher?

Sometimes it is necessary or desirable to create taller walls without the installation of geogrid. The Base Block allows just that.

By using the base block, you can build a ten foot (10') high wall with no soil reinforcement. This is particularly beneficial in situations where certain excavating is needed behind the wall, such as the placement of poles or fencing.

The base block has the same face dimensions as the landscape block but is twice as deep. So, at 24" high x 48" wide x 52" deep, the base block provides a large surface area for a very stout wall.

The base block interlocks with the standard landscape block, so you can mix and match as you see fit.

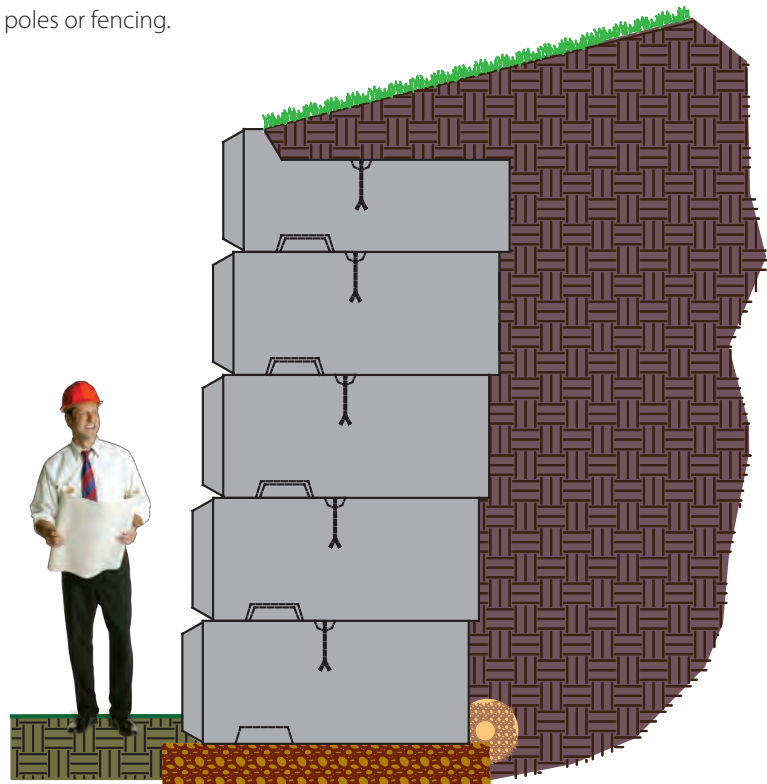

## World Block and Retain Pro

If you design retaining walls you know it is tedious and time consuming. Retain Pro software makes it easier. Much easier! World Block Landscape Blocks are now integrated into the program itself. In minutes you can design or analyze nearly any configuration or loading

condition for your World Block retaining walls. Accepted, established and in use in over 150 city, county and federal plan review agencies, Retain Pro is the go-to leader in retaining wall design software. Download it now at [www.retain-pro.com](http://www.retain-pro.com)



## MID-SIZE LANDSCAPE BLOCK FORMS



### MID-SIZE LANDSCAPE BLOCK FORM

If you are looking for a landscape block that is large enough for the most demanding job, yet small enough to be handled with light-duty equipment, the Mid-size Landscape Block Form is the perfect form for you.

The Mid-Size Landscape Block looks great in residential settings. Where larger blocks tend to overwhelm the scale of a house, the Mid-Size Block looks

right at home, even though the wall has the same mass as one built from our larger Landscape Blocks. Each block weighs only 560 pounds. That's light enough to be handled with a skid-steer. Why is that important?

Landscape contractors typically do not have the heavy equipment needed to move and place larger blocks. The Mid-Size Landscape Block is small enough to handle and allows

them to move up in class beyond the small blocks sold at hardware stores.

The Mid-Size Landscape Block steps back one inch on every course allowing it to lean back into the earth it is retaining. And with tapered sides, the Mid-Size Landscape Block can create curved walls with a radius as tight as 6 feet to the back of the block.

We now offer two styles of forms: the single cavity which

makes one block at a time and the four-cavity. The four-cavity form creates four blocks with one pour of 16 cubic feet of concrete.

Working with either of the Mid-Size Landscape Form is as simple as all the rest of our forms. Two "L" shaped halves snap together with heavy-duty, over-center locking clamps. The four cavity form locks around a center cross piece. The blocks are poured face







**The Mid-Size Landscape Block is large enough for the most demanding job, yet small enough to be handled with light-duty equipment."**

down with a liner on placed on the bottom to create the rock face of the block.

The Half Block Divider simply bolts into one of the cavities of your form. A Half Block Liner is placed on either side of the divider and allows you to pour two half blocks with one pour.

Most customers will pour twice a day with one form: pour it in the morning, let it set up all day, strip it in the evening, pour it again and let it set up all night.

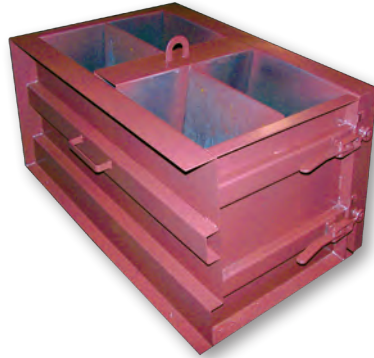

■ **MID-SIZE LANDSCAPE BLOCK FORM**

Sku Number: MS-10104  
Block Weight: 560 lbs.  
Volume: 3.73 cu. ft.  
Form Weight: 465 lbs

**\$1,747.00**

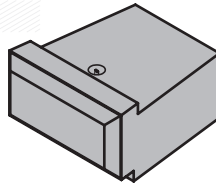

■ **MID-SIZE LANDSCAPE HALF BLOCK DIVIDER**

Sku Number: MS-1020B  
Block Weight: 280 lbs.  
Volume: 1.87.  
Form Weight: 35 lbs

**\$173.00**

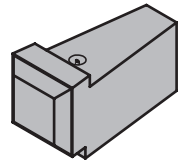

■ **12" X 24" X 3" MID-SIZE LANDSCAPE LINER**

Sku Number: FL-MDS017  
Form Weight: 15 lbs

**\$183.00**

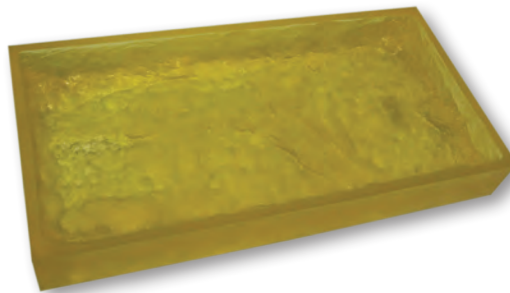

■ **12" X 12" X 3" MID-SIZE HALF BLOCK LINER**

Sku Number: FL-MDS020  
Form Weight: 5 lbs

**\$92.00**

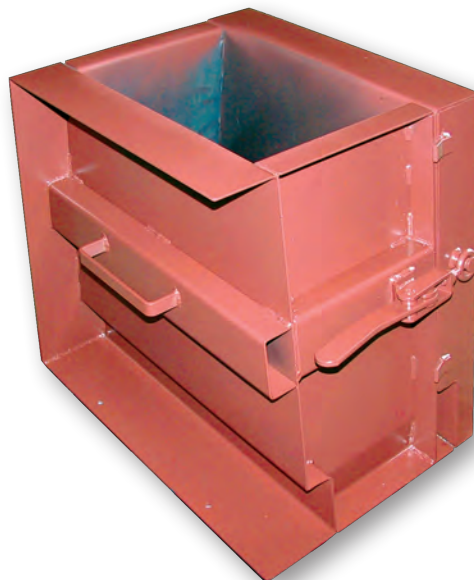
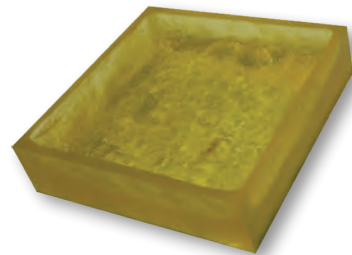

**YOU ASKED FOR IT, YOU GOT IT. THE SINGLE CAVITY MID-SIZE BLOCK FORM IS:**

- **SMALLER**
- **LIGHTER**
- **EASIER TO HANDLE**
- **EASIER TO USE!**

■ **SINGLE CAVITY MID-SIZE BLOCK FORM**

Sku Number: MS-MS10101  
Block Weight: 560 lbs.  
Volume: 3.73 cu. ft.  
Form Weight: 156 lbs

**\$545.00**

## ■ MID-SIZE LANDSCAPE BLOCK FORMS

“The smaller size of the Mid-Size Landscape Block is better proportioned for residential landscaping.”

Carlson Concrete  
Duluth, MN

**ALL  
NEW!**

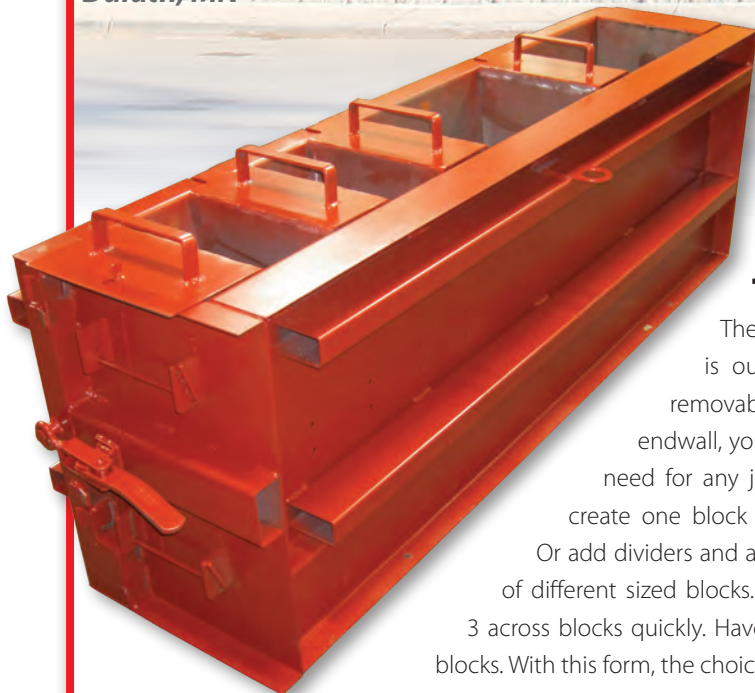

### **THREE ACROSS MID-SIZE BLOCK FORM:**

**WHEN YOU'VE GOT  
A LONG WAY TO GO  
AND A SHORT TIME  
TO GET THERE.**

The Three Across Mid-Size Block Form is our most versatile form ever. With removable form dividers and an adjustable endwall, you can make exactly the blocks you need for any job. Without any dividers you can create one block that looks like 3 separate blocks. Or add dividers and adjust the endwall to make a series of different sized blocks. Making a long, straight wall? Lay 3 across blocks quickly. Have to turn a curve, set down single blocks. With this form, the choice is yours.

- **USES STANDARD LINERS**
- **SET MULTIPLE BLOCKS AS ONE**
- **PLACE WALLS FASTER**
- **HAS UP TO A 6 FT<sup>2</sup> FACE**

### ■ **THREE ACROSS MID-SIZE LONG BLOCK FORM**

Sku Number: MS-10103  
Block Weight: 1680 lbs.  
Volume: 11.2 cu. ft.  
Form Weight: 415 lbs

**\$1,543.00**

\*comes with (2) dividers

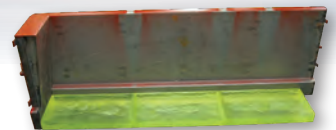

■ (1) 6' BLOCK



■ (1) 2' & (1) 4' BLOCKS



■ (3) 2' BLOCKS

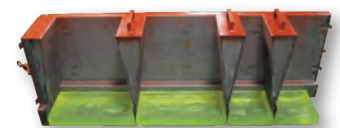

■ (2) 2' & (2) 1' BLOCKS



■ **CORNER BLOCK FORM**

(LEFT)

Sku Number: MS-1040FL  
 Block Weight: 405 lbs  
 Volume: 2.70 cu. ft.  
 Form Weight: 125 lbs

**\$557.00**

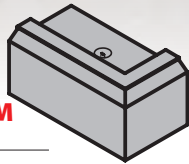

(RIGHT)

Sku Number: MS-1040FR  
 Block Weight: 405 lbs  
 Volume: 2.70 cu. ft.  
 Form Weight: 125 lbs

**\$557.00**

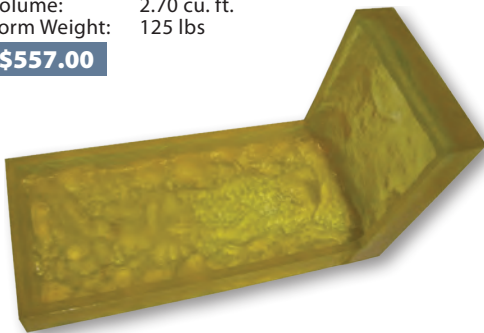

■ **12"X15"X3" X 12"X27"X3"**  
**CORNER BLOCK LINER**

Sku Number: FL-MDS125  
 Form Weight: 30 lbs

**\$339.00**

Corner blocks are used when you need to turn a 90° outside corner. It also can be used to simply create a textured face at the end of a wall to finish it off. The "L" shaped liner fits in the bottom and up one side of the form. While a separate left and right form are required, the liner will fit in both the left and right forms by simply flipping it over.



■ **3" X 3" CORNER SHIM**

With this handy little device there is no need to buy a corner liner for your corner forms. This piece fits into the corner of a corner block form allowing you to use a standard 12 x 24 liner and a 12 x 12 liner to make a corner block.

Sku Number: MS-SHIM  
 Form Weight: 5 lbs

**\$32.00**



## MID-SIZE LANDSCAPE BLOCK FORMS

### TOP CAP FORM

Sku Number: MS-1050F  
Block Weight: 450 lbs  
Volume: 3.00 cu. ft.  
Form Weight: 150 lbs

**\$407.00**

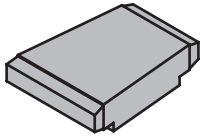

### 6" X 24" X 3"

### TOP CAP LINER

(PAIR)  
Sku Number: FL-MDS303  
Form Weight: 15 lbs

**\$178.00**

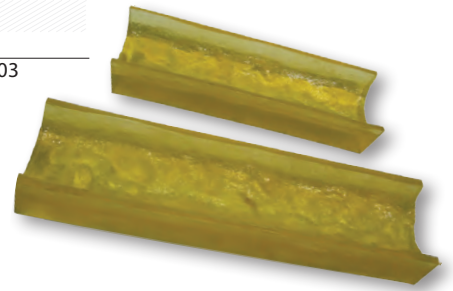

The Top Cap Form creates a block 6 inches high, 24 inches wide at the front and 18 inches wide at the back. The liners fit into the front and back of the form. When the blocks are laid head to toe they will lie straight. Laid head to head

they will curve back. Laid toe to toe they will curve in. The liners have open ends so they will butt seamlessly against the adjoining block face.



### 7 X 30 X 7 X 48 LANDSCAPE STEP LINER

Sku Number: FL-LDS301  
Form Weight: 40 lbs

**\$370.00**



This form creates one step 30" deep x 48" wide with a 7" high riser and a stone face on three sides. To create stairs simply stack one on top of another allowing for desired tread depth. The one piece "U" shaped liner wraps around the front and two sides.

### STEP FORM

Sku Number: LS-STEP  
Block Weight: 875 lbs  
Volume: 5.83 cu. ft.  
Form Weight: 210 lbs

**\$461.00**

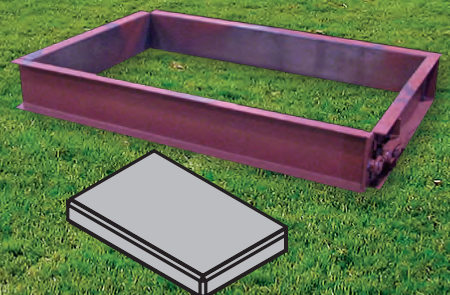

**RECESS BLOCKOUT**

Sku Number: MS-R1010  
 Block Weight: 520 lbs  
 Volume: 3.47  
 Form Weight: 30 lbs

**\$154.00**

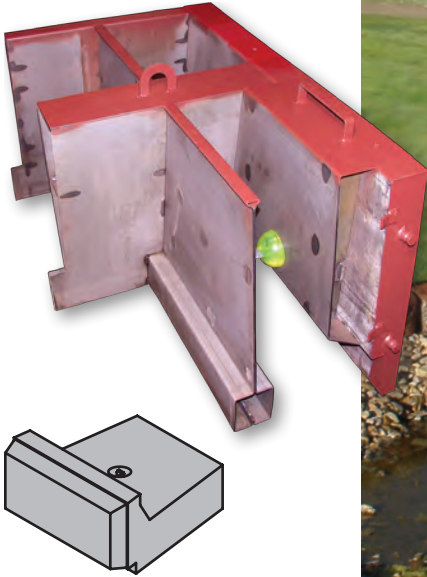

The Recess Blockout helps this creek run through a golf course.

Top caps may not be appropriate for all situations. Recess blockouts bolt directly onto your existing form and create a six inch recess in the top of the block.

If you are backfilling behind your wall, this void allows you to fill up and over the top of your wall. It is deep enough for any landscaping to take root.

**THE PROBLEM:**

Mid-Size Landscape blocks step back 1 inch on every course. When using corner blocks, they also step in 1 inch to adjust for the wall running in the other direction. If only one corner block is used, this offset is unnoticeable and easy to deal with. When using two corners, as shown below, the wall gets squeezed 2 inches on each course.

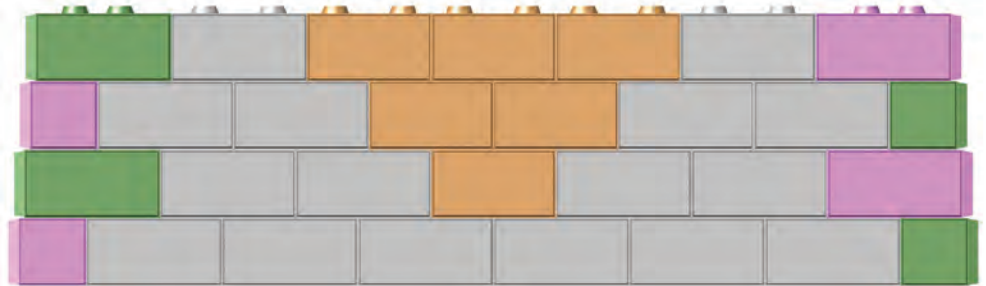

**THE SOLUTION:**

Key blocks are 2 inches shorter than the standard block - 22 inches versus 24. Use one additional key block for each successive course feeling the squeeze. For example, on the first course no key blocks are required. The second course needs one key block, the third course needs two, the fourth course needs three, and so on.

**KEY BLOCK BLOCKOUT**

Sku Number: MS-1030B  
 Block Weight: 500 lbs  
 Volume: 3.33  
 Form Weight: 25 lbs

**\$117.00**



**KEY BLOCK LINER**

Sku Number: FL-MDS019  
 Form Weight: 13 lbs

**\$168.00**

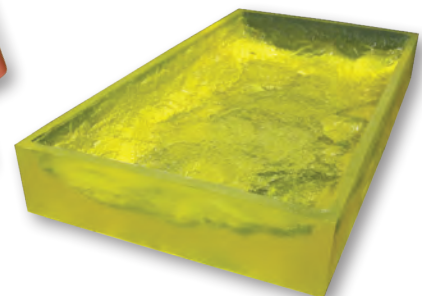

■ QUARRY STONE LINER

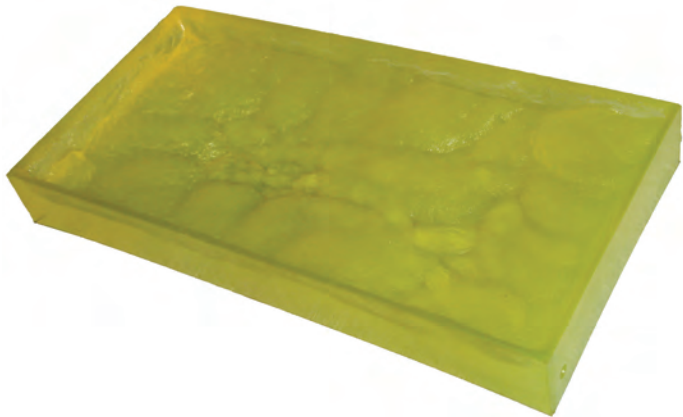
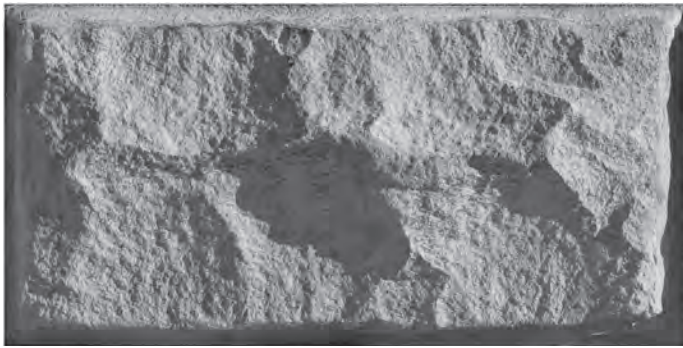

**O**ptions. You want options. Up until now the liner face for Mid-Size Blocks have been limited. Well, not any more. We are happy to announce our brand new

Quarry Stone Liner for Mid-Size Block Forms.

This is the one you have been asking for. With the distinct facial features of a rock that has been chipped away by someone who knows what

■ MID-SIZE ORIGINAL LINER

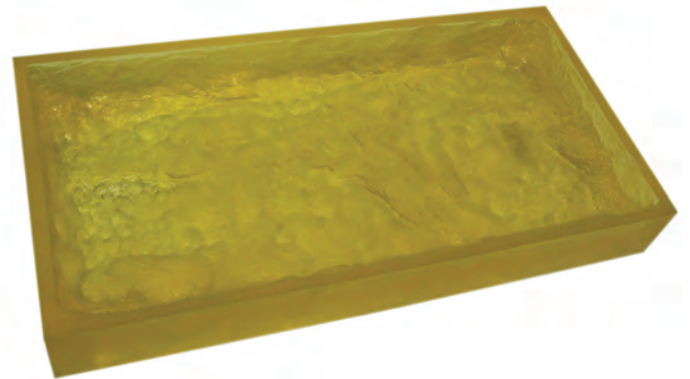

they are doing it provides the depth and contrast to make your walls look beautiful.

Not to worry, though. We are still making the Original Rock Face for Mid-Size. Yes, the same one that has been specifically

designed to reduce the "repetative pattern" syndrom that plaques so many of our competitors.

Both liners have 4 different faces for 8 different looks (right sight up and upside down).



## 6 foot Wall

Graded Surface

Engineered Backfill

Provide Adequate Drainage Material

Compacted Granular Engineered Base

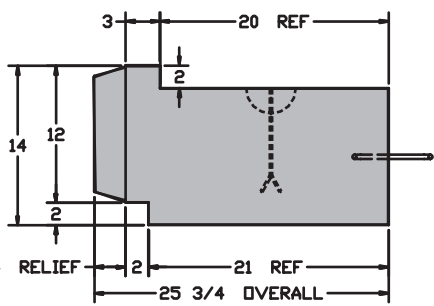
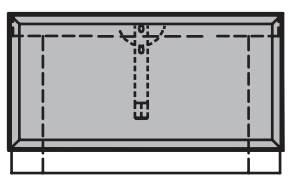
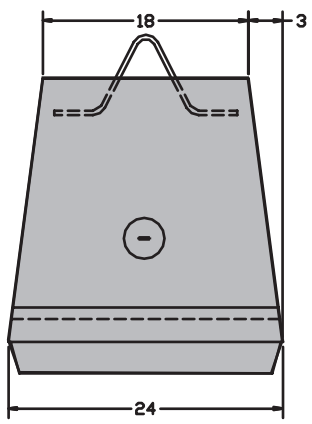

Warning: No construction should be undertaken without professionally engineered specifications for the site and issuance of proper permits.

**Call Now 218-728-9481**

# WELCOME TO W

## YOU ARE ON THE MAP

It is our greatest desire to see you succeed. To that end we want to drive as much traffic to you as possible. World Block has created an all-new, incredibly powerful,



**It is our greatest desire to see you succeed."**

interactive map which places every World Block producer location on our website. It is, by far, the most visited page on our site: End users come to our site in an effort to find you. World Block now gives you complete control over what information you want to display on our map. Not just a spot on the map, now you can include logos, pictures, documents, even a link to your own webpage. We believe giving you that kind of control over how you are presented will

allow you to make the most of this effective tool.

## THE WORLD

When you buy from World Block you are automatically granted membership to World Block World, a place to that brings our community together to share information, pictures, tips, and tricks. This is a site where we can disseminate all of the secrets of our customers across the community. We want to bring companies together. When you sell a block,

you are not selling just a block. You are selling a wall. Building a wall requires skill sets across many industries: Concrete, Landscape Engineering, and Construction, to name a few. Every project is different, but many of the problems that arise are not. There are many companies across this country that may have already experienced your particular head-scratcher. Now you can ask them directly. It is our firm belief that together we can accomplish amazing things.





# WORLD BLOCK

## COOPERATION LEADS TO SUCCESS

When you purchase from World Block you join the largest



**Every project is different, but many of the problems that arise are not."**

community of block builders on the planet. Our dedication to unrestricted free-enterprise creates an open playing field which leads to a level of cooperation and

collaboration that is unmatched in the industry. Competition in a location has given way to cooperation allowing World Block members to join forces and tackle larger projects than they could ever handle by themselves. It also causes engineers to spec in World Block into projects knowing that there is always a company nearby to get the job done. Together we are an incredibly powerful force. Welcome aboard.

## YOUR WALL NEEDS TO BE ON OUR COVER

You have a wall project that needs to be shared. It needs to be displayed in a place of prominence where other, like-minded individuals can appreciate just how impressive it is. We have just the place: The cover of the World Block catalog.

If you think you have a picture stunning enough to be on the cover, upload it here to enter the Cover Photo Contest. Winners will receive a \$500 World Block credit, a globe rating for your World Block World profile, and space on the cover for that fantastic looking wall of yours.

## THE RULES

- You must be a current World Block customer.
- You must enter the contest through your account at [WorldBlockWorld.com](http://WorldBlockWorld.com).
- All photos must be "World Block" related.
- Please let us know what blocks and liners were used and any other information you think others might enjoy.
- Clean, finished wall shots are more likely to be selected for the World Block Cover Photo contest. Installation shots are acceptable if showing a certain technique. Messy job-site photos should be avoided.
- Good cover shots include uncluttered space at the top of the photo for the World Block Logo (think blue sky).
- Pictures should be at least 1530 x 1890 pixels at 180 dpi resolution (8.5 inches x 10.5 inches in a press quality resolution)
- Each photo is judged on its own merits. Similar photos may result in different outcomes.

## ■ V-INTERLOCK BLOCK FORMS



**The granddaddy of all block forms, the V-Interlock block form has been used for years in the industry as the go-to form .**

*Matter Contracting  
Coxsackie, NY*

**D**own and dirty, the V-Interlock Block is not meant to be pretty, it's meant to get the job done. At 2 feet high, 2 feet wide and 6 feet long, the block form takes 24 cubic feet of concrete to make a 3,600 pound block. If you need to get rid of a cubic yard of concrete, this form will do the trick.

The granddaddy of all block forms, the V-Interlock block form has been used for years in the industry as the go-to form for straight-forward, get-it-done-now applications. These blocks are perfect (and most commonly used) for industrial applications such as batch plant fencing and product divider bins.

A raised "male" V notch runs along

the top and down one side of the block while an inner "female" V notch runs along the bottom and up the other side. V-Interlock blocks are the only blocks to interlock on all four sides.

Built as two "L" shaped halves your forms lock together at the corners using two heavy-duty, over-center locking clamps. This design allows for easy set up and stripping. The clamps can be used as levers to help you pop the form open after the block has cured.

A convenient liftpoint blockout is already welded in place. Our lifting loops make the easiest and most affordable lift point. Simply slide one end of the cable loop into the slot of the blockout and you are ready to pour. Some customers have found it helpful to stuff a rag behind the liftpoint

or cover the slot with duct tape to prevent concrete from oozing out. The reinforced sidewalls make your forms rigid enough to handle the biggest load.

The forms are poured with the face down. The sides of the form make the top, bottom and sides of the block. After stripping, just grab the liftpoint and tip the block upright.

To make a more decorative block use a form liner. These durable urethane liners are placed on the bottom of the form and create stone patterns on the front of your blocks.

Straight walls are easy to create. You will only need two forms. A 6 foot form will create blocks for the bulk of the wall. And a 3 foot form will offset the end for a running bond pattern. Getting rid of concrete has never been easier.

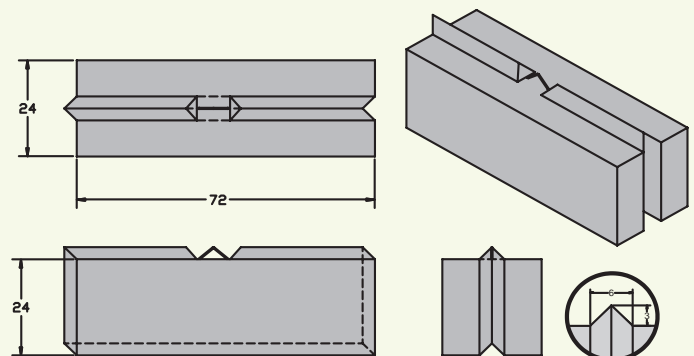

### ■ 2' X 2' X 6' STRAIGHT

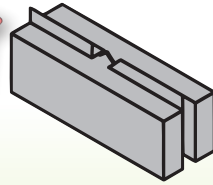

■ Sku Number: **VC-STR72**  
 Form Weight: **300 lbs**  
 Block Weight: **3,600 lbs**  
 Volume: **24.00 cu. ft.**

**\$626.00**

### ■ 2' X 2' X 4' STRAIGHT

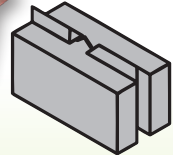

■ Sku Number: **VC-STR48**  
 Form Weight: **200 lbs**  
 Block Weight: **2,400 lbs**  
 Volume: **16.00 cu. ft.**

**\$604.00**

### ■ 2' X 2' X 3' STRAIGHT

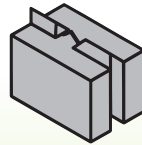

■ Sku Number: **VC-STR36**  
 Form Weight: **185 lbs**  
 Block Weight: **1,800 lbs**  
 Volume: **12.00 cu. ft.**

**\$580.00**

### ■ 2' X 2' X 2' STRAIGHT

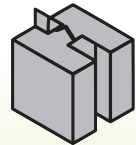

■ Sku Number: **VC-STR24**  
 Form Weight: **150 lbs**  
 Block Weight: **1,200 lbs**  
 Volume: **8.00 cu. ft.**

**\$568.00**



**Call Now 218-728-9481**

## ■ V-INTERLOCK BLOCK FORMS

**W**hen you make a junction, be it just a corner

or a "T" intersection, you will need a special block to do the job. World Block has all the forms you need to make any of these connections.

The V-Interlock Blocks have a V-groove running along its lengths. Any intersection of your wall must address this groove.

While this may seem tricky at first, once you get the hang of it, it's a piece of cake. And, of course, if you have any questions, you can just give us a call.



■ 2' X 2' X 5'  
**CORNER**



■ Sku Number: **VC-CNR60**  
Form Weight: **255 lbs**  
Block Weight: **3,000 lbs**  
Volume: **20.00 cu. ft.**

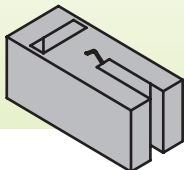

**\$789.00**

■ 2' X 2' X 4'  
**CORNER**



■ Sku Number: **VC-CNR48**  
Form Weight: **195 lbs**  
Block Weight: **2,400 lbs**  
Volume: **16.00 cu. ft.**

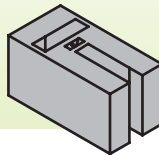

**\$714.00**

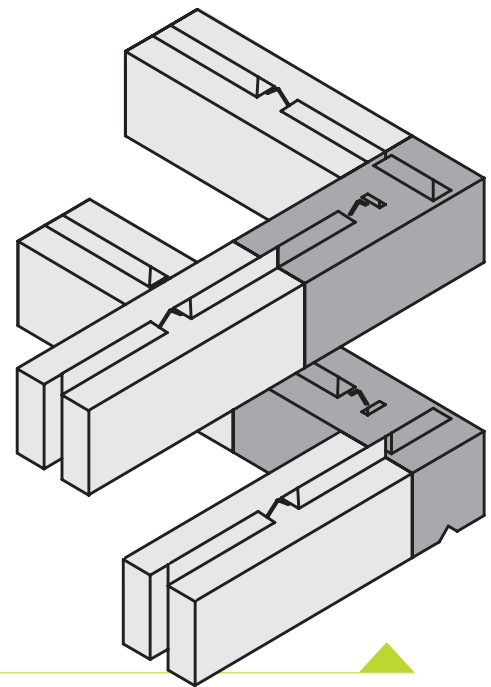

The corner block is used to interlock overlapping corner blocks. This block has one two-foot section of the top V-groove turned 90° allowing it to accept the groove of the block placed on top of it.

Because the corner block overlaps the block below it by 2 feet, the 5 foot length will allow you to maintain your running bond after turning the corner.

2' X 2' X 5'  
**T-BLOCK**



■ Sku Number: **VC-TBL60**  
 Form Weight: **255 lbs**  
 Block Weight: **3,000 lbs**  
 Volume: **20.00 cu. ft.**

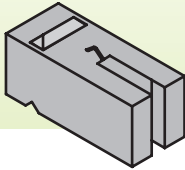

**\$894.00**

2' X 2' X 4'  
**T-BLOCK**



■ Sku Number: **VC-TBL48**  
 Form Weight: **200 lbs**  
 Block Weight: **2,400 lbs**  
 Volume: **16.00 cu. ft.**

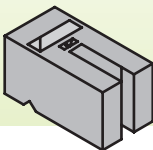

**\$830.00**



**What if I don't have enough concrete to fill my form?**

Not a problem. The face of the block is the only part of the block that people will see. Because your blocks are poured face down, the block face will always look good. If you run out of concrete, simply drop a couple of pieces of rebar in the wet concrete. When you have more concrete, fill it up the rest of the way. The rebar will lock the two pours together.

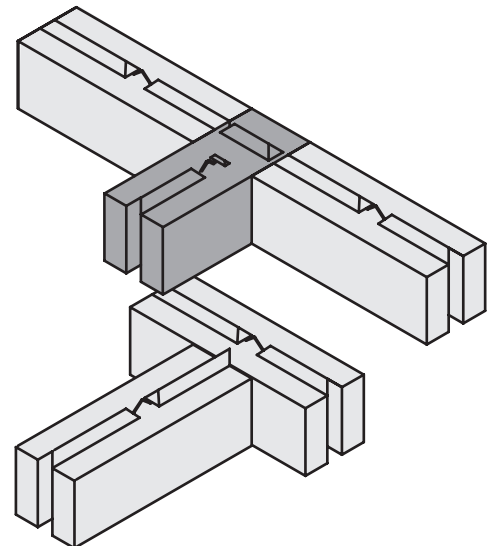

The T-block is used for creating "T"junctions for partition walls. The block can be used as both a corner block and a T-block. This block has one two-foot section of top V-groove turned 90° and one two-foot section of bottom V-groove turned 90° allowing it to interlock

with blocks running above and below it. Because the T-block overlaps the block below it by 2 feet, the 5 foot length will allow you to maintain your running bond after turning the corner.

**Call Now 218-728-9481**

## V-INTERLOCK BLOCK FORMS



### V-INTERLOCK BLOCK FORMS

**T**his block can be used as a straight, corner or "T" block. The combination block is designed just like the straight block

with the addition of two V-grooves that are turned 90° running across the bottom. These grooves are set back from edge by 2" to hide the notches when they are used as straight blocks.

To use the block as a corner or "T" block simply break off that chunk of concrete. Also this setback provides enough space to use liners with the form.

#### 2' X 2' X 6' COMBINATION



■ Sku Number: **VC-CMB72**  
 Form Weight: **310 lbs**  
 Block Weight: **3,600 lbs**  
 Volume: **24.00 cu. ft.**

**\$798.00**

#### 2' X 2' X 4' COMBINATION



■ Sku Number: **VC-CMB48**  
 Form Weight: **210 lbs**  
 Block Weight: **2,400 lbs**  
 Volume: **16.00 cu. ft.**

**\$721.00**



**T**here are two different ways to make a top cap for your V-Interlock Blocks. The first is with a Top Cap Insert. The Top Cap Insert is placed lengthwise into your existing six foot block form. The insert will create a 12" high cap with chamfered edges and is flush with the sides of the blocks underneath it. Note that it retains the end interlocks. The second way is with

a separate Top Cap Form. This form creates a top cap that is 26" wide x 6' long x 6" high with a 12:2 pitch to center peak (8" thick at center) and 1 inch overhang on each side of block. It is poured upside down and flipped over using the trunnions on each end. Loosen the quickbolts on each corner and release the V-notch pan and your block will slide right out. Used with a 45° Top Cap Blockout you can neatly turn a 90° corner.



### TOP CAP BLOCKOUT

- Sku Number: **VC-CAP72B**
- Form Weight: **175 lbs**
- Block Weight: **1,800 lbs**
- Volume: **12.00 cu. ft.**

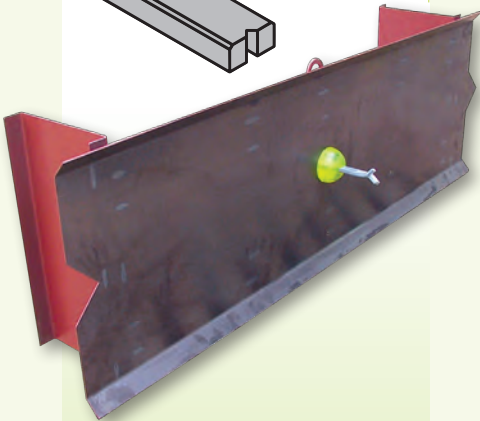
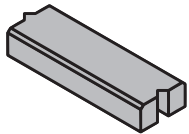

**\$294.00**

### TOP CAP FORM

- Sku Number: **VC-CAP72F**
- Form Weight: **365 lbs**
- Block Weight: **1,050 lbs**
- Volume: **7.00 cu. ft.**

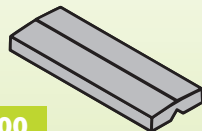
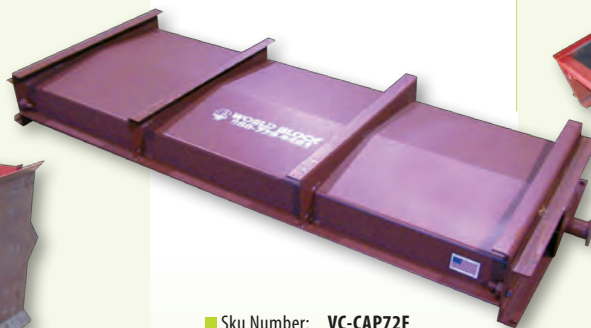

**\$787.00**

### 45° TOP CAP BLOCKOUT

- Sku Number: **VC-CAP45B**
- Form Weight: **20 lbs**
- Block Weight: **900 lbs**
- Volume: **6.00 cu. ft.**

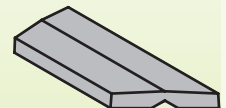

**\$52.00**



**Underground Specialties  
Oldcastle, ON**

**J**ust about the simplest block form out there, the knob style block form makes life easy. With two knobs on top fitting into two knobs on the bottom, these blocks fit together like giant Legos®.

We have 2 sizes of Knob Style blocks: 24"x24"x48" requiring 16 cubic feet of concrete (making a 2,400 pound block) and 30"x30"x60" requiring 31 cubic feet of concrete (making a 4,700 pound block).

This block is purposely built half as wide as they are long. Because of this, turning a corner does not require buying extra forms or pouring special blocks. The knob placement and block dimensions allow you to simply

turn your block 90° at a corner and maintain a running bond.

The forms are built as two "L" shaped halves that lock together with heavy-duty, over-center locking clamps for easy set-up and stripping. The clamps can be used as levers to help you pop the form open after the block has cured. This design allows you to get many pours per day from one form. After your first pour has set, strip the form and leave the block to cure. Then set the form up and pour again. Depending on your mixture you can get two, three, even four blocks per day from one form.

The blocks are poured face down. After stripping, grab the liftpoint and tip upright. To

make a more decorative block use a form liner. These durable urethane liners are placed on the bottom of the form to create decorative stone patterns on the face of your blocks.

Half blocks can be created in two ways: in a separate form or with a blockout. The blockouts fit inside your existing, full form allowing you to pour in half of the form. The only disadvantage to using a blockout is that it will tie up your large form for at least one pour. If you do decide to use a half block blockout, two holes will have to be drilled in the top knob of the form to hold the rubber liftpoint blockout. When not pouring half blocks, a piece of duct tape will cover the holes perfectly.

Similarly, top cap blocks can be made with either a form or a blockout. And the same rules apply - if you use a blockout you tie up a form. You can also create half top caps.

When you reach the end of a wall it can sometimes look better to slope the wall down rather than end it abruptly. For these instances we offer a Sloped End Blockout that fits securely into the corner of the form. You can create right and left slopes by moving the blockout from one corner to the other.

With the form's ease of use and the block's simple functionality, it is no surprise that some of our most popular block forms are knob style.





■ 24" X 24" X 48" FULL KNOB  
BLOCK FORM

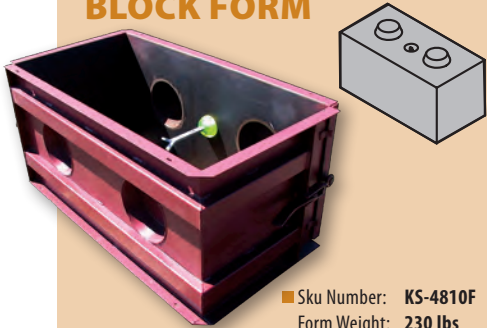

■ Sku Number: **KS-4810F**  
Form Weight: **230 lbs**  
Block Weight: **2,400 lbs**  
Volume: **16.00 cu. ft.**

**\$932.00**

■ 12" X 24" X 48" FULL KNOB  
TOP CAP FORM

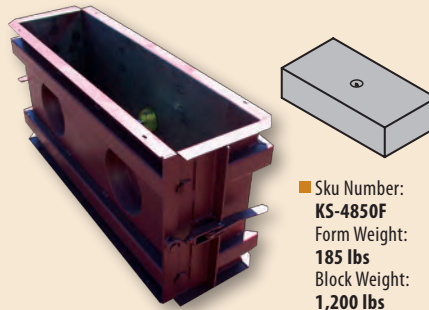

■ Sku Number: **KS-4850F**  
Form Weight: **185 lbs**  
Block Weight: **1,200 lbs**  
Volume: **8.00 cu. ft.**

**\$868.00**

■ 12" X 24" X 24" HALF KNOB  
TOP CAP FORM

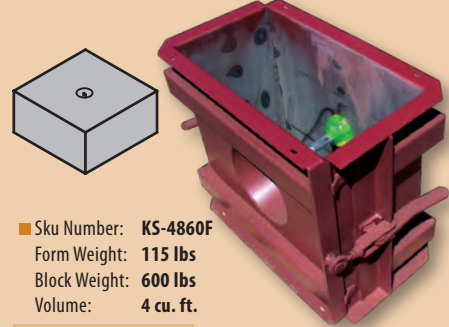

■ Sku Number: **KS-4860F**  
Form Weight: **115 lbs**  
Block Weight: **600 lbs**  
Volume: **4 cu. ft.**

**\$642.00**

■ 24" X 24" X 24" HALF KNOB  
BLOCK FORM

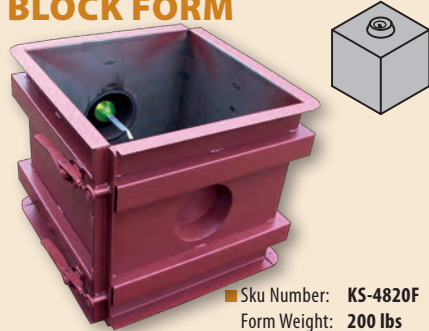

■ Sku Number: **KS-4820F**  
Form Weight: **200 lbs**  
Block Weight: **1,200 lbs**  
Volume: **8.00 cu. ft.**

**\$794.00**

■ BLOCKOUT

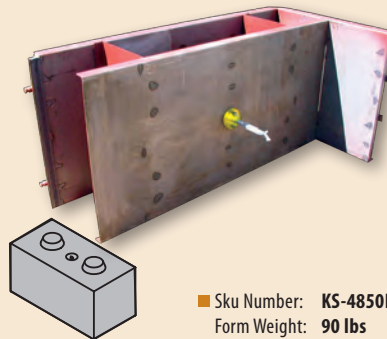

■ Sku Number: **KS-4850B**  
Form Weight: **90 lbs**  
Block Weight: **1,200 lbs**  
Volume: **8.00 cu. ft.**

**\$290.00**

■ BLOCKOUT

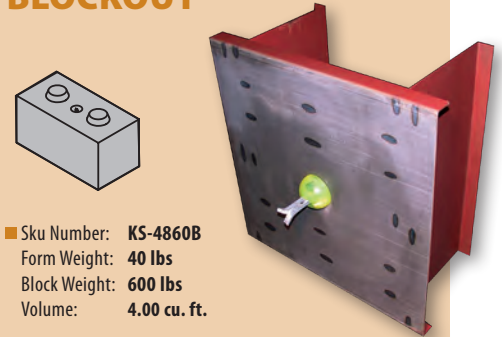

■ Sku Number: **KS-4860B**  
Form Weight: **40 lbs**  
Block Weight: **600 lbs**  
Volume: **4.00 cu. ft.**

**\$270.00**

■ BLOCKOUT

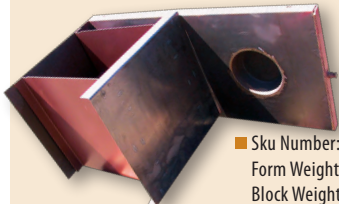

■ Sku Number: **KS-4820B**  
Form Weight: **90 lbs**  
Block Weight: **1,200 lbs**  
Volume: **8.00 cu. ft.**

**\$270.00**

■ 24" X 24" X 48" KNOB  
SLOPED END BLOCKOUT

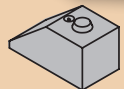

■ Sku Number: **KS-4870B**  
Form Weight: **80 lbs**  
Block Weight: **1,800 lbs**  
Volume: **12.00 cu. ft.**

**\$525.00**

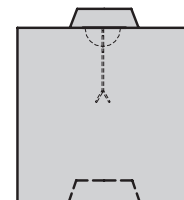
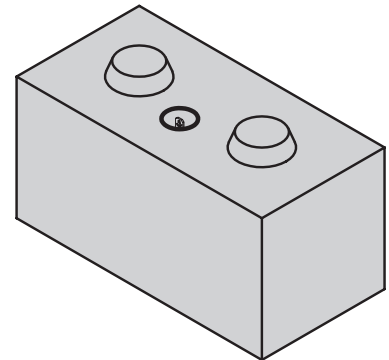
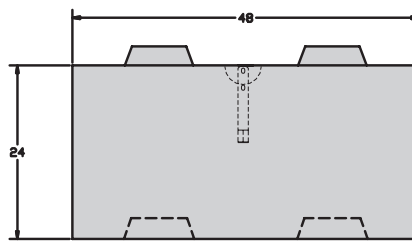
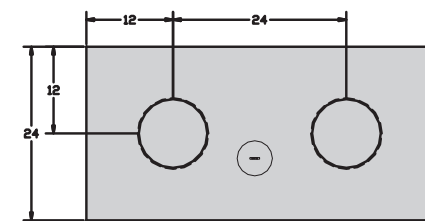

## ■ KNOB STYLE BLOCK FORMS

### ■ 30" X 30" X 60" FULL KNOB BLOCK FORM

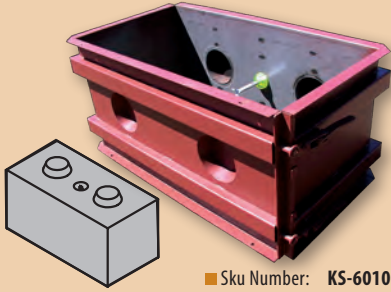

■ Sku Number: **KS-6010F**  
 Form Weight: **370 lbs**  
 Block Weight: **4,700 lbs**  
 Volume: **31.33 cu. ft.**

**\$998.00**

### ■ 15" X 30" X 60" FULL KNOB TOP CAP FORM

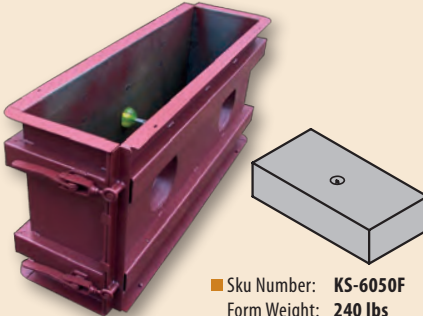

■ Sku Number: **KS-6050F**  
 Form Weight: **240 lbs**  
 Block Weight: **2,350 lbs**  
 Volume: **15.67 cu. ft.**

**\$932.00**

### ■ 15" X 30" X 30" HALF KNOB TOP CAP FORM

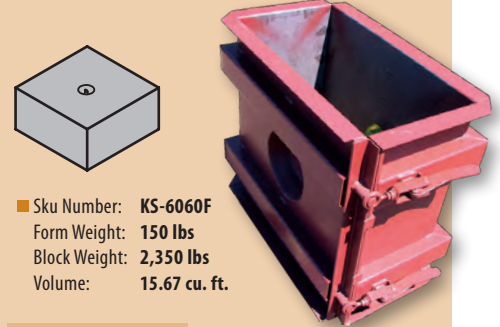

■ Sku Number: **KS-6060F**  
 Form Weight: **150 lbs**  
 Block Weight: **2,350 lbs**  
 Volume: **15.67 cu. ft.**

**\$698.00**

### ■ 30" X 30" X 30" HALF KNOB BLOCK FORM

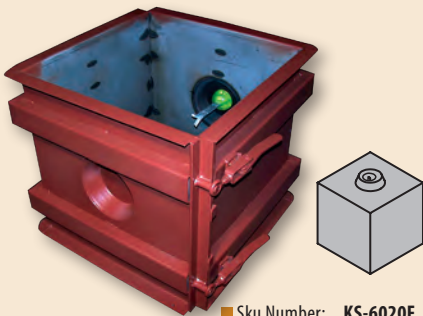

■ Sku Number: **KS-6020F**  
 Form Weight: **260 lbs**  
 Block Weight: **2,350 lbs**  
 Volume: **15.67 cu. ft.**

**\$825.00**

### ■ 15" X 30" X 60" FULL KNOB BLOCKOUT



■ Sku Number: **KS-6050B**  
 Form Weight: **125 lbs**  
 Block Weight: **2,350 lbs**  
 Volume: **15.67 cu. ft.**

**\$321.00**

### ■ 15" X 30" X 30" HALF TOP CAP BLOCKOUT



■ Sku Number: **KS-6060B**  
 Form Weight: **55 lbs**  
 Block Weight: **1,175 lbs**  
 Volume: **7.83 cu. ft.**

**\$290.00**

### BLOCKOUT

■ Sku Number: **KS-6020B**  
 Form Weight: **125 lbs**  
 Block Weight: **2,350 lbs**  
 Volume: **15.67 cu. ft.**

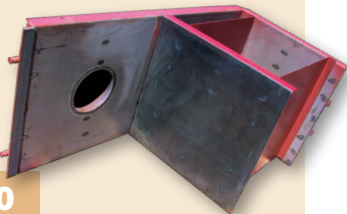

**\$290.00**

### ■ 30" X 30" X 60" SLOPED END BLOCKOUT

**\$557.00**

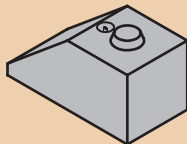

■ Sku Number: **KS-6070B**  
 Form Weight: **115 lbs**  
 Block Weight: **3,500 lbs**  
 Volume: **23.33 cu. ft.**

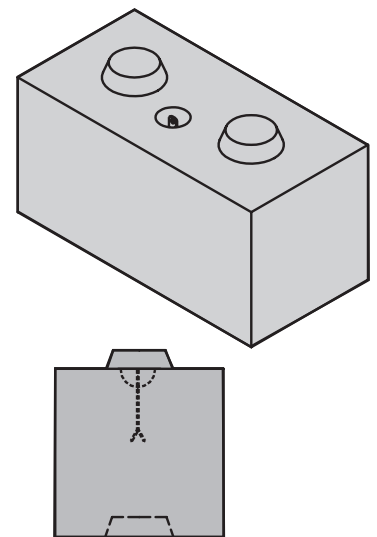
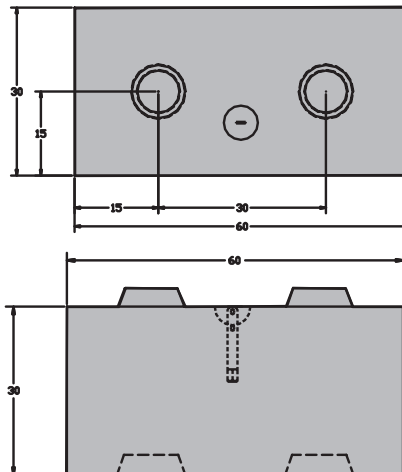

The biggest of the Knob Blocks, the Jumbo Block certainly knows how to throw its weight around. Weighing in at 5,400 pounds with 36 cubic feet of concrete, the Jumbo Block stays where you put it. Working just like the knob style block form, with its simple interlocking system, the Jumbo Block makes an imposing wall.

The front face of the block is a well proportioned 2 feet by 6 feet. At 3 feet deep the block is half as deep as it is long and will easily turn a corner without disrupting your running bond pattern.

When you need to make a big wall, you need a big block. The Jumbo Block will fit the bill.

■ 24" X 36" X 72" JUMBO  
**BLOCK FORM**

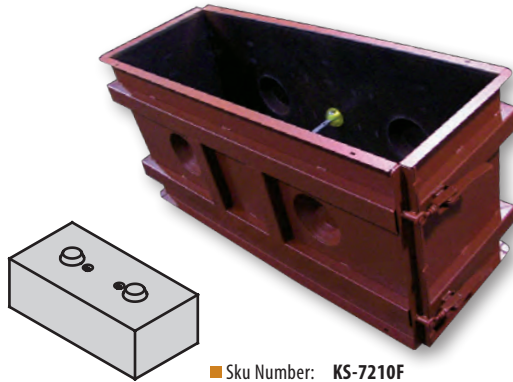

■ Sku Number: **KS-7210F**  
Form Weight: **580 lbs**  
Block Weight: **5,400 lbs**  
Volume: **36.00 cu. ft.**

**\$1,214.00**

■ 24" X 36" X 36" JUMBO  
**HALF BLOCK (BLOCKOUT)**

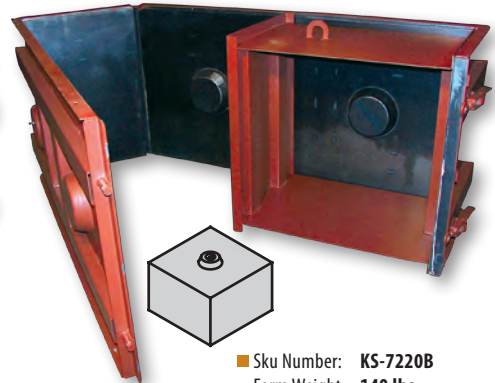

■ Sku Number: **KS-7220B**  
Form Weight: **140 lbs**  
Block Weight: **2,700 lbs**  
Volume: **18.00 cu. ft.**

**\$352.00**

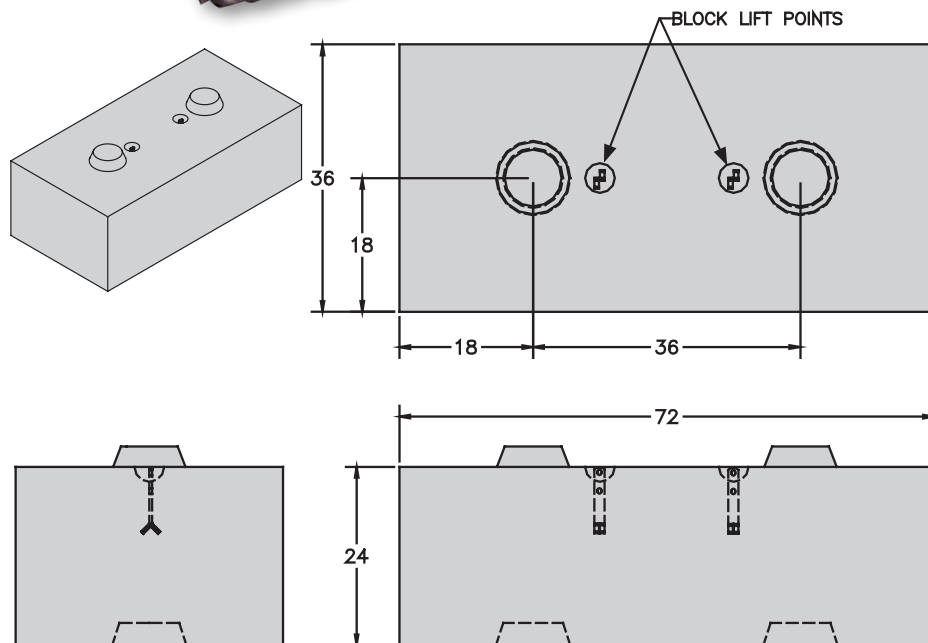

## OTHER BLOCK FORMS

**P**arking curb forms are a great product to make when you have just a little bit of concrete to get rid of. Our curb forms are incredibly easy to use. Fill them up, let them cure, and flip them over. The curb will slip out like an ice cube from a tray.

The curbs come in one standard dimension to fit every state's requirements. At 5-1/2" they are stout enough to stop a car yet low enough to avoid scraping a bumper.

The notch pans are loose pieces that are set into place after pouring. Similarly the pin hole formers are stuck into the concrete and simply pulled out after the curb cures.



### SINGLE FORM



#### 6' SINGLE FORM

■ Sku Number: **PC-725**  
Form Weight: **50 lbs**  
Block Weight: **225 lbs**  
Volume: **1.5 cu. ft.**

**\$214.00**

#### 7' SINGLE FORM

■ Sku Number: **PC-845**  
Form Weight: **60 lbs**  
Block Weight: **275 lbs**  
Volume: **1.83 cu. ft.**

**\$235.00**

#### 8' SINGLE FORM

■ Sku Number: **PC-965**  
Form Weight: **70 lbs**  
Block Weight: **325 lbs**  
Volume: **2.16 cu. ft.**

**\$257.00**

**How do I flip this thing?**

After the concrete cures, remove the pins from the support bar. Using straps or a turning frame, flip the form upside down and support the curbs from the bottom (with a forklift or 4 x 4's). Remove the support bars and release your curbs.

### ADJUSTABLE TURNING FRAME

**\$1,233.00**

■ Sku Number: **PC-TF**  
Weight: **325 lbs**

Our turning frame works with your parking curb gang form to easily flip the form and release the curbs. Braces hold the curbs in place when turning. Please specify 6', 7', or 8' parking curb gang form.



### HOLE PINS (PAIR)

**\$32.00**

■ Sku Number: **PC-PIN**  
Weight: **5 lbs**

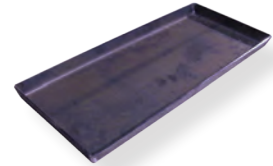

### NOTCH PANS (PAIR)

**\$61.00**

■ Sku Number: **PC-PAN**  
Weight: **16 lbs**

### 5 GANG FORM



#### 6' GANG FORM

**\$2,037.00**

■ Sku Number: **PC-72G**  
Form Weight: **625 lbs**  
Block Weight: **225 lbs**  
Volume: **7.5 cu. ft.**

#### 7' GANG FORM

**\$2,176.00**

■ Sku Number: **PC-84G**  
Form Weight: **650 lbs**  
Block Weight: **275 lbs**  
Volume: **9.25 cu. ft.**

#### 8' GANG FORM

**\$2,315.00**

■ Sku Number: **PC-96G**  
Form Weight: **675 lbs**  
Block Weight: **325 lbs**  
Volume: **10 cu. ft.**



**T**his little form does it all: gets rid of just enough concrete and makes a block that is easy to handle yet so versatile. The block dimensions are 18" x 18" x 18" creating a chunk of concrete that weighs 500 pounds.

Use it with a standard lifting loop to create an anchor for commercial tents. Or use the special blockouts to create a hole straight through the block. One is designed specifically for 4x4 posts, the other for fence posts. Use them for fences, signage, mailboxes, etc. There is also a trailer hitch insert to embed in the block. Now you can lock your camper or boat to something secure.

This block is great for all sorts of uses. If you need this block to do something else, let us know and we'll make a blockout for you.



4 x 4 Blockout

Fence Post Blockout

■ **UTILITY BLOCK FORM**

**UTILITY BLOCK FORM**

■ Sku Number: **UB-3387**  
 Form Weight: **90 lbs**  
 Block Weight: **500 lbs**  
 Volume: **3.33 cu. ft.**

**\$270.00**

**FENCE POST BLOCKOUT (PAIR)**

■ Sku Number: **UB-3388**  
 Form Weight: **5 lbs**

**\$40.00**

**4X4 BLOCKOUT (PAIR)**

■ Sku Number: **UB-3389**  
 Form Weight: **6 lbs**

**\$45.00**

**Call Now 218-728-9481**

## ■ OTHER BLOCK FORMS

So, you have just a little bit of concrete left. And, we are talking just a little bit. What are you going to do? Try making a paver block. This urethane mold creates a 12" x 12" x 3" paver block with a slate-style relief on its surface.

It's easy to use, just fill it up, let it cure, flip it over, and pop it off. The urethane walls are thick enough to prevent bowing, yet flexible enough for easy stripping.

The slate finish on top has just enough relief to be interesting, and add some grip to be walked on. Being wet-cast these pavers will last a whole lot longer than any dry-cast pavers found at DIY stores.

Get a few of them to have around when you need them. They forms are easy to use, and the blocks are easy to sell.

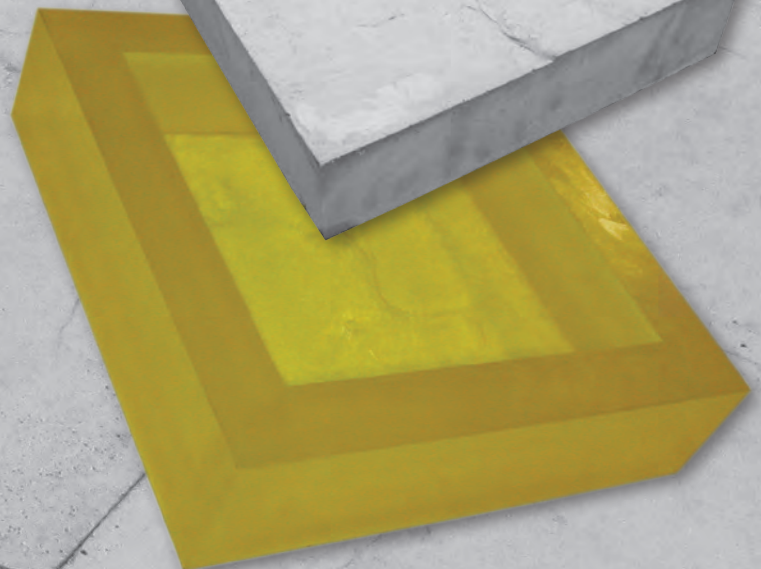
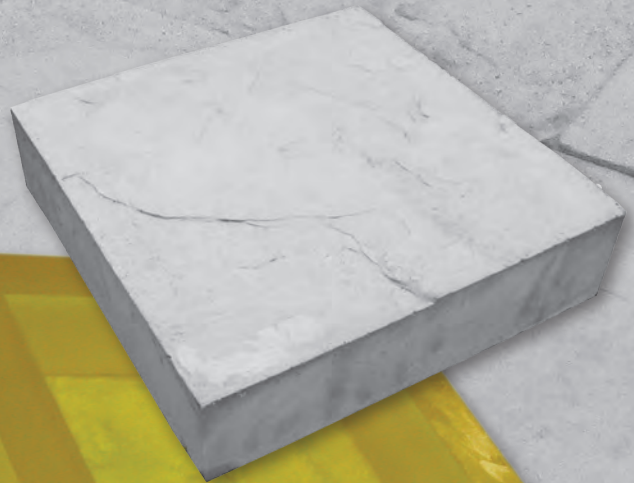
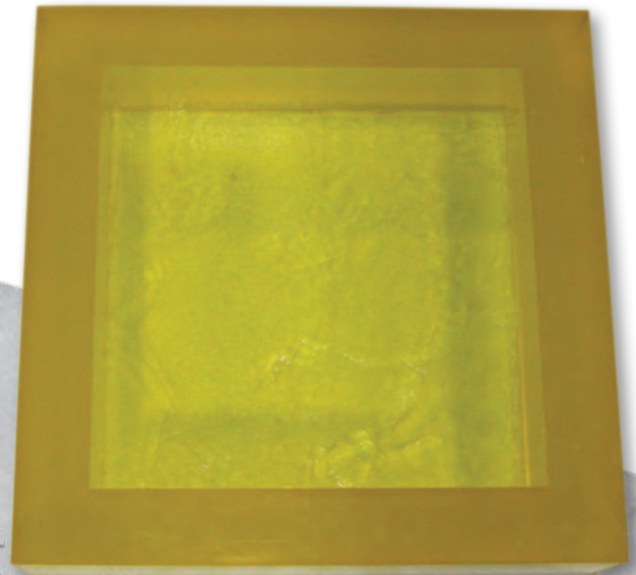

### ■ 12" X 12" X 3" - SLATE

#### PAVER MOLD

■ Sku Number: **PM-3392**  
Form Weight: **15 lbs**  
Block Weight: **37.5 lbs**  
Volume: **.25 cu. ft.**

**\$162.00**





# WORLD BLOCK'S GOAL IS TO ACHIEVE TOTAL CUSTOMER SATISFACTION THROUGH MEETING AND EXCEEDING YOUR EXPECTATIONS.



## PRICES:

- This price list supercedes all previous published price lists.
- All prices are quoted F.O.B. Duluth, Minnesota (US Funds).
- Prices do not include freight, unloading at job site, set-up or any costs incurred to meet local codes.
- Any federal, state or municipal tax applicable is the purchaser's responsibility.
- WORLD BLOCK is continually improving its products - therefore specifications & prices may change without prior notice.

## CREDIT AND PAYMENT TERMS:

- New accounts will require 3 credit references and a down payment to establish credit. World Block reserves the right to set credit limits, down payment amounts and payment terms for each sale. Unpaid balances that are past due may be subject to a late payment charge of 1-1/2% per month.
- We require prepayment on all out of country orders.
- Payments must be paid in US funds.



## WORLD BLOCK, INC.

**ADDRESS:** 3964 East Calvary Road  
Duluth, MN 55803

**PHONE:** 218-728-9481

**TOLL FREE:** 888-728-9481

**FAX:** 218-728-1730

**E-MAIL:** info@worldblock.com

**WEB SITE:** www.worldblock.com

We accept all major credit cards.



Design: www.eontendencies.com

**Call Now 218-728-9481**



## ■ FORM LINERS



**Liners add dimension and visual interest to this retaining wall.**

*VS Virkler & Son  
Lowville, NY*

**A**dding a decorative face to your concrete blocks adds value without adding cost.

Meaning you can charge more for your blocks using the same amount of concrete. It's no wonder that this is one of the fastest growing segments of the concrete industry. World Block offers a wide array of urethane liners to simply and efficiently create decorative stone patterns on the face of your finished blocks. Our liners come in three different depths, 1", 2" and 4". The thicker liner will give you a deeper, more aggressive texture.

World Block Forms are poured face down. To use a liner you

simply place the liner at the bottom of the form and fill it up with concrete. After stripping the form, tip the block upright and the liner will peel right off. Your block will then have your chosen pattern on its face.

World Block Liners are made of a very durable, 75 durometer urethane. With proper care you can expect to get hundreds of uses from your form liner. Don't leave them out to dry and crack in the elements. And be sure to use the proper release agent with them.

While there are many release agents to choose from, we have developed the World Block Plus formula to work specifically with our liners. If you decide to use an agent other than World

Block Plus be sure to test it to insure it doesn't shrink, expand or otherwise eat away at your liners.

Coloring your blocks can be done in three different ways. Either with an admixture colorant, a colored power release agent, or a concrete stain. Most people are using stains to color their block walls. A typical application is to spray on a base coat over the entire wall. This covers any variations of color from block to block. Then two or three more colors can be sponged, or ragged onto the individual "stones" to create a more natural look.

Form liners are very easy to use and increase value without adding material costs. You

make more money without pouring more concrete. That's getting something for nothing!

Our liners come in a variety of thicknesses. This not only affects the cost, but the look of the finished block. A 2 inch thick liner has a deeper relief than a 1 inch liner. Generally speaking a deeper relief will give you more contrast and greater detail. But before making a decision, think about the finished wall's use. If it's on the side of a highway, detail won't matter much at 50 yards and 50 mph. If the wall is being constructed in a park where people will get close to it, the detail and depth of a thicker liner might be the way to go.







With proper care you can expect to get hundreds of uses from your form liner."

**1" CUT STONE** (PAGE 28)



**1" RIVER ROCK**



**1" RANDOM STACK** (PAGE 29)



**1" ROCK FACE**



**2" SLATE** (PAGE 42)



**2" CHISELED STONE**



**2" RIVER STONE**



**2" LIMESTONE** (PAGE 26)



**2" SPLIT FACE**

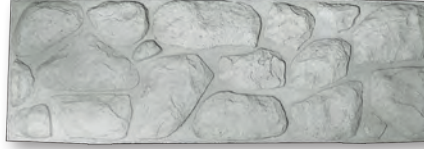

How do I color my blocks?

**You can color your blocks in three ways:**

1. Concrete stain. Spray on a first light-colored coat on the finished block and rag on 2-3 darker colors.
2. Add colorant to your concrete before you pour.
3. Sprinkle a color hardener on the bottom of the form before

**4" LANDSCAPE** (PAGE 1)

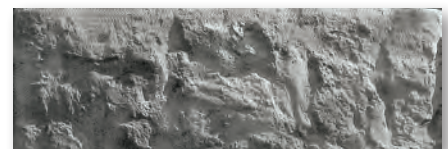

**4" MULTI-STONE** (PAGE 44)



**1" LINER PRICING**

24"X72"X1"	50 lbs	\$447.00
24"X60"X1"	42 lbs	\$392.00
24"X48"X1"	34 lbs	\$333.00
24"X36"X1"	26 lbs	\$279.00
24"X24"X1"	18 lbs	\$220.00
30"X60"X1"	55 lbs	\$460.00
30"X30"X1"	27 lbs	\$285.00

**2" LINER PRICING**

24"X72"X2"	80 lbs	\$473.00
24"X60"X2"	67 lbs	\$409.00
24"X48"X2"	53 lbs	\$351.00
24"X36"X2"	40 lbs	\$290.00
24"X24"X2"	27 lbs	\$227.00
30"X60"X2"	85 lbs	\$484.00
30"X30"X2"	43 lbs	\$295.00

**4" LINER PRICING**

24"X72"X4"	90 lbs	\$653.00
24"X60"X4"	77 lbs	\$569.00
24"X48"X4"	60 lbs	\$472.00
24"X36"X4"	52 lbs	\$387.00
24"X24"X4"	35 lbs	\$290.00
30"X60"X4"	100lbs	\$678.00
30"X30"X4"	50 lbs	\$393.00

# CHAMFERED COLUMN CORNER

**B**ig, bold and beautiful. That's what the Chamfered Column Corner looks like. This simple liner adds a dramatic impact to any project. It creates the look of having a stack of giant cornerstone blocks anchoring your wall.

Dramatic, but very simple to use. This liner turns up the 24" end of your block, and covers 24" of the face. If you are using a 5' corner block form, place a 36" liner next to the Chamfered Column Corner Liner. If you are using a 4' corner block, place a 24" liner next to it. Remember to flip the form for alternating left and right corners.

When you stack the corner blocks, the Chamfered Column Corners line up creating this powerful pattern.

Simple, versatile, and distinctive. This one liner will make creating all of your corners so much easier.

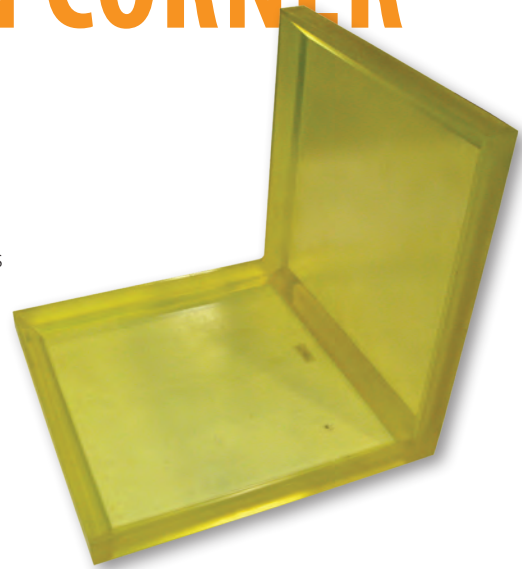

■ 24" X 24" X 24" X 24" X 2"  
CHAMFERED COLUMN  
CORNER LINER

Sku Number: FL-CHM106  
Form Weight: 60 lbs

**\$453.00**



The Chamfered Column Corner Liner creates an imposing cornerstone look to this wall. Slate liners were used to create the face."

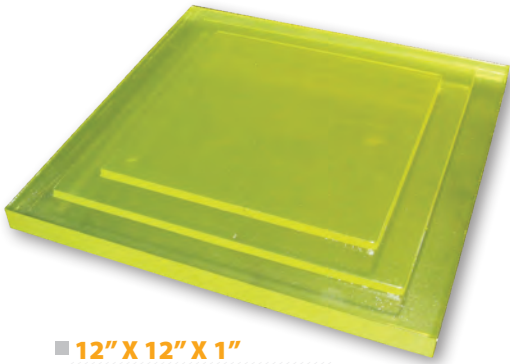

■ **12" X 12" X 1"**  
**PANTHEON LINER**

Sku Number: FL-PAN020  
 Form Weight: 15 lbs

**\$38.00**

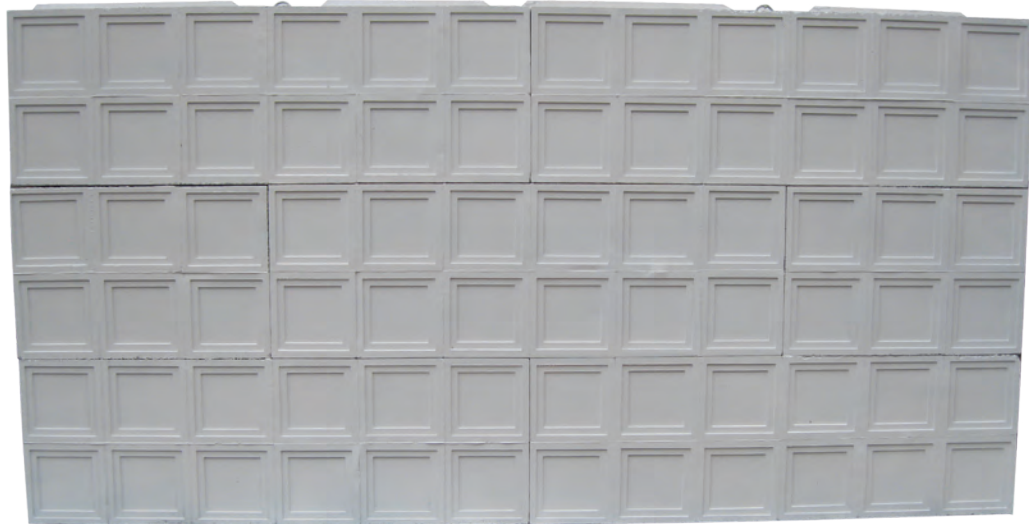

# THE 12" X 12" LINER

**W**e've noticed a trend. Perhaps you have noticed it too. More and more architects and engineers are asking for architectural designs in their block faces. Less rock, more decoration. Well, we decided to see where this trend will lead.

Here are some liners that are as flexible as they are good looking - and they are only 12" square. Here's how they work: If you have a 2' X 6' form you would use 12 of these liners. If you have a 2' X 4' form you

would use only 8 of these liners. Other than that, they work just like a regular liner.

The Pantheon Liner (above) was named after the design of the Pantheon's domed ceiling in Rome. The Pyramid Liner (below) comes to a 1/2" peak.

Each liner shifts with the changing light, sure to make all the architect and engineers you deal with very happy.

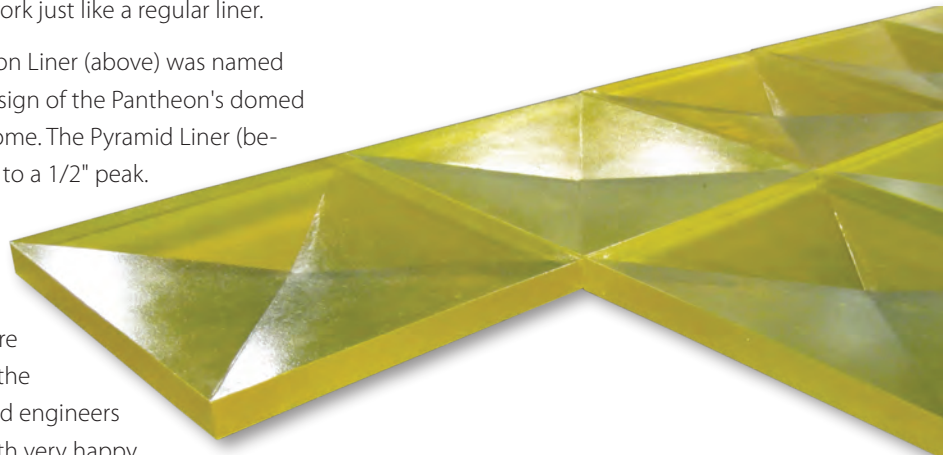

Patterns shift with the changing light."

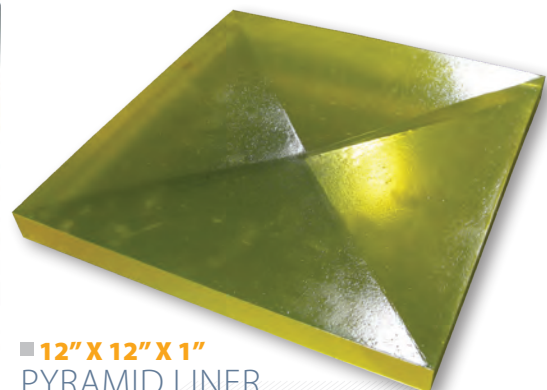

■ **12" X 12" X 1"**  
**PYRAMID LINER**

Sku Number: FL-PYR020  
 Form Weight: 15 lbs

**\$38.00**

**Call Now 218-728-9481**

## ■ FORM LINERS

### THE RANDOM STACK LINER

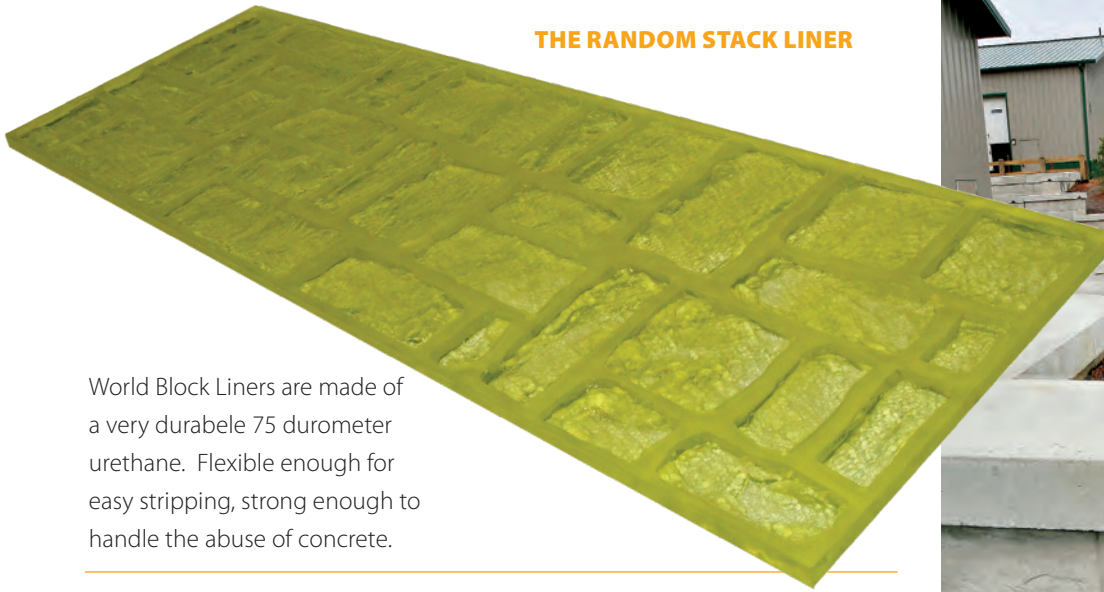

World Block Liners are made of a very durable 75 durometer urethane. Flexible enough for easy stripping, strong enough to handle the abuse of concrete.

**We recommend using World Block Plus Form and Liner Release Agent especially when you are using World Block liners. Your form liners are a big investment and need to be treated with care. Do not leave them in the elements**

**and use the correct release agent.**

**Different release agents interact differently with urethane and we know World Block Plus works with our liners.**



**Blocks made with the Cut Stone Liner.**

### ■ FORM LINER INSTRUCTIONS

- Place liner in the bottom of your form, relief side up.
- Apply a light coat of World Block Plus Form Release Oil to the surface of the liner.
- Pour concrete into block form as usual.
- After the block has set, strip the block from the form and set the block upright.
- Remove the liner from the finished product.
- Prior to using the form liner again, clean any remaining concrete off the face of the form liner. This is best accomplished by brushing it with a stiff bristle brush.



**Blocks made with the Multi-Stone Landscape Liner.**



## WORLD BLOCK PLUS FORM RELEASE AGENT

Our release agent is formulated with organic chemicals to prevent adhesion for quick, easy release of your forms and liners. Cuts clean-up time and will create a rust proof film on your forms. Can be stored indefinitely.

**\$53.00** ■ Sku Number: **AC-120**  
Weight: **43 lbs**

**5 Gallons**



**Where did the drum go?**

We will no longer be selling drums or totes of release agent. We were being asked to collect taxes not just in the states we were selling into, but also each county within those states. That is just too much for us to handle. Give us a call and we will point you in the right direction.

## SPRAYER

How do you apply release agent? The easiest way is to spray it on. This Chapin Industrial Sprayer is built specifically for release agents by spraying 30-35% solids. It has a wide mouth for easy filling and cleaning. A 14" heavy duty brass pump with an ergonomical pump handle makes pressurizing the tank easy and comfortable. A 24 inch curved brass extension wand for getting into the nooks and crannies makes this the perfect tool to use with World Block Plus Release Agent.

**\$104.00** ■ Sku Number: **SP-060**  
Weight: **11 lbs**



**\$29.00** ■ Sku Number: **AC-140**  
Weight: **3.5 lbs**

## 10" HEAVY-DUTY, OVER-CENTER LOCKING CLAMPS

All of World Block forms are built using these heavy duty clamps. They hold tight by snapping locked over center. The bent handle offers an easy grip. The fine thread eyebolt offers accurate adjustments and stronger resistance to force.



■ Sku Number: <b>AC-190</b> Weight: <b>.7 lbs</b>	■ Sku Number: <b>AC-180</b> Weight: <b>.6 lbs</b>	■ Sku Number: <b>AC-160</b> Weight: <b>.5 lbs</b>
------------------------------------------------------	------------------------------------------------------	------------------------------------------------------

## CLAMP LUGS

The 3/4" diameter clamp lugs with radius notch are designed to work precisely with either our 10" or 15" over center locking clamps.



**\$45.00** ■ Sku Number: **AC-111**  
Weight: **5 lbs**

## RUBBER KNOB BLOCKOUT

Bolts into the raised knobs of your form to create a flat surface on top of your block.

## ■ ACCESSORIES

### SWIVEL HOOK

Whether you are using "U" Anchors or Lifting Loops, this 360 degree rotating, self locking, 3.15 ton swivel hook will help place your block while setting up your wall. The rotation allows you to manipulate your block easier while it is suspended in the air, saying goodbye to the kink in your chain. A 3.15 ton chain shackle is included to connect to your system.



**\$63.00**

■ Sku Number: **SP-020**  
Weight: **5 lbs**

### 7/16" LIFTPPOINT BLOCKOUT FOR "V"

Fits into V-Interlock Liftpoint Space for use with 7/16" U-Anchor



**\$30.00**

**7/16" V-BLOCKOUT**  
■ Sku Number: **AC-040V**  
Weight: **2 lbs**

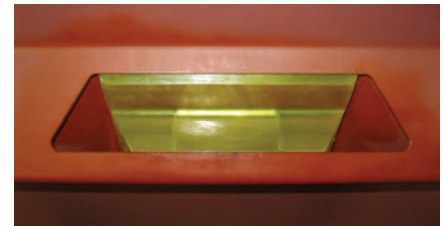

### INSTALLATION

This urethane piece needs to fit tight, so prepare to wrestle with this for a little bit. Applying some release agent directly to the Blockout will make it easier to snap in place. Once it is in, you'll need a screwdriver to pry it out (but it works so well, we doubt you'll want to do that).

### REBAR LIFTPPOINT BLOCKOUT (BOLTED)

The Rebar Liftpoint Blockout is needed when using a bent piece of rebar as your liftpoint. This blockout has a "tooth" that holds the rebar in place while pouring. Remove the bolts from the blockout before stripping. You can then pop the blockout out from the concrete.

**Rebar does not have a safety rating. Please use caution if you intend to go this route.**



**\$40.00**

■ Sku Number: **AC-010**  
Weight: **3 lbs**



**L**ifting a large concrete block is definitely something you want to know how to do before you have a one-ton chunk of concrete lying around your facility.

Our Liftpoint Blockouts are the easiest and safest method of creating a liftpoint. They bolt permanently to the side of your form to create a pocket in the top of your block for access to the liftpoint. Our pre-engineered U-Anchors and Lifting Loops fit securely into the slot on the blockout while pouring.

The Liftpoint Blockout does not have to be unbolted when stripping: it will easily pull away from the U-Anchor or Lifting Loop as you open the form. Either method will dramatically cut the time and hassle out of cutting, bending and inserting rebar for your blocks.



## 1/4" LIFTPPOINT BLOCKOUT

fits 1/4" U-Anchor and 1/4" Lifting Loop



**\$30.00**

**1/4" BLOCKOUT**

■ Sku Number: **AC-020**  
Weight: **2 lbs**

## 1/4" U-ANCHOR

For use with Mid-Size Landscape block forms (Rated to 1,600 lbs)

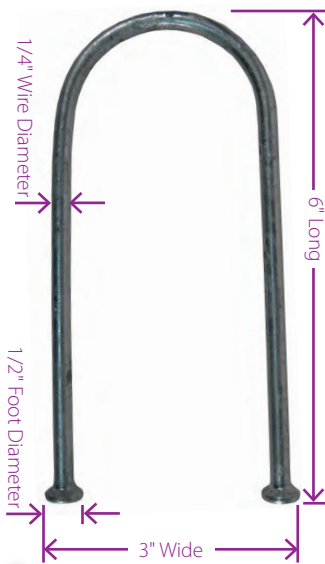

**\$1.65**

■ Sku Number: **AC-021**  
Weight: **2.7 oz.**

Only: **\$1.45** when ordering over (100)

## U-ANCHORS

Made of galvanized carbon steel to prevent rust, the U-Anchor is the most economical lifting anchor on the market. U-anchors were designed specifically for lifting precast modular blocks.

## 3/8" LIFTPPOINT BLOCKOUT

fits 3/8" U-Anchor and 3/8" Lifting Loop



**\$30.00**

**3/8" BLOCKOUT**

■ Sku Number: **AC-030**  
Weight: **2 lbs**

## 3/8" U-ANCHOR

For use with Landscape and 24 x 48 Knob Style block forms (Rated to 4,690 lbs.)

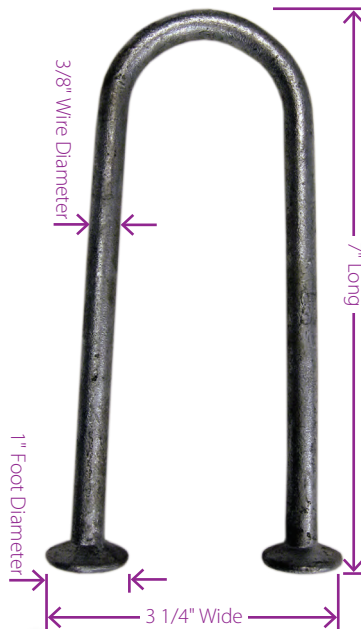

**\$1.99**

■ Sku Number: **AC-031**  
Weight: **8.8 oz.**

Only: **\$1.79** when ordering over (100)

## 7/16" LIFTPPOINT BLOCKOUT

Fits 7/16" U-Anchor



**\$30.00**

**3/8" BLOCKOUT**

■ Sku Number: **AC-040**  
Weight: **2 lbs**

## 7/16" U-ANCHOR

For use with V-Interlock and 30 x 60 Knob Style block forms (Rated to 7,500 lbs)

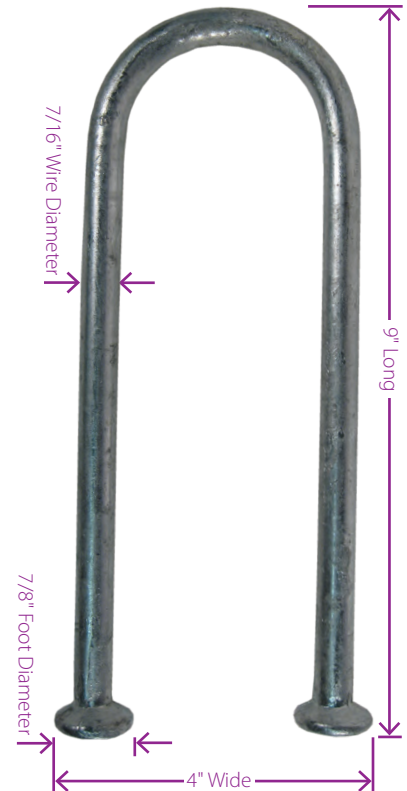

**\$2.55**

■ Sku Number: **AC-041**  
Weight: **16.5 oz.**

Only: **\$2.35** when ordering over (100)

**Call Now 218-728-9481**



3964 East Calvary Road  
Duluth, MN 55803

# YOUR WALL NEEDS TO BE ON OUR COVER

**Send us pictures.  
Get on the cover.  
Win \$500.  
Brag.**



**\$500**

[WWW.WORLDBLOCK.COM](http://WWW.WORLDBLOCK.COM)