

Landscape Block

Geogrid Connection & Interface Shear

Test Results

by World Block Inc.

PART “A”

GRID CONNECTION TESTING



SGI TESTING SERVICES

A GEORGIA LIMITED LIABILITY COMPANY

3 June 2019

Mr. Mike Orton
SRW Products, Inc.
P.O. Box 70
Princeton, MN 55371

Subject: Laboratory Test Results Transmittal
Connection Strength Testing
SRW Geogrids and Landscape Blocks

Dear Mr. Orton,

SGI Testing Services, LLC (SGI) is pleased to present the attached test results for the above-mentioned testing program. The note section below addresses sample preparation, sample disposal and a disclosure statement.

SGI appreciates the opportunity to provide laboratory testing services to SRW Products. Should you have any questions regarding the attached document(s), or if you require additional information, please do not hesitate to contact the undersigned.

Sincerely,

Zehong Yuan, Ph.D., P.E.
Laboratory Manager

Attachments

NOTES:

- (1) Unless otherwise noted in the test results the sample(s)/specimen(s) were prepared in accordance with the applicable test standards or generally accepted sampling procedures.
- (2) Contaminated/chemical samples and all related laboratory generated waste (i.e., test liquids, PPE, absorbents, etc.) will be returned to the client or designated representative(s), at the client's cost, within 60 days following the completion of the testing program, unless special arrangements for proper disposal are made with SGI.
- (3) Materials that are not contaminated will be discarded after test specimens and archived specimens are obtained. Archived specimens will be discarded 30 days after the completion of the testing program, unless long-term storage arrangements are specifically made with SGI.
- (4) The reported results apply only to the materials and test conditions used in the laboratory testing program. The results do not necessarily apply to other materials or test conditions. The test results should not be used in engineering analysis unless the test conditions model the anticipated field conditions. The testing was performed in accordance with general engineering testing standards and requirements. The reported results are submitted for the exclusive use of the client to whom they are addressed.

SGI19029.2019.01

MAIL TO: SGI TESTING SERVICES, LLC
P.O. BOX 2427
LILBURN, GA 30048-2427

FACILITY LOCATION
4405 INTERNATIONAL BLVD., SUITE B-117
NORCROSS, GA 30093

WEB SITE: WWW.SGILAB.COM

PHONE: 770.931.8222 FAX: 770.931.8240

**SCHEMATIC DIAGRAM OF TEST CROSS-SECTION
CONNECTION STRENGTH TESTING**

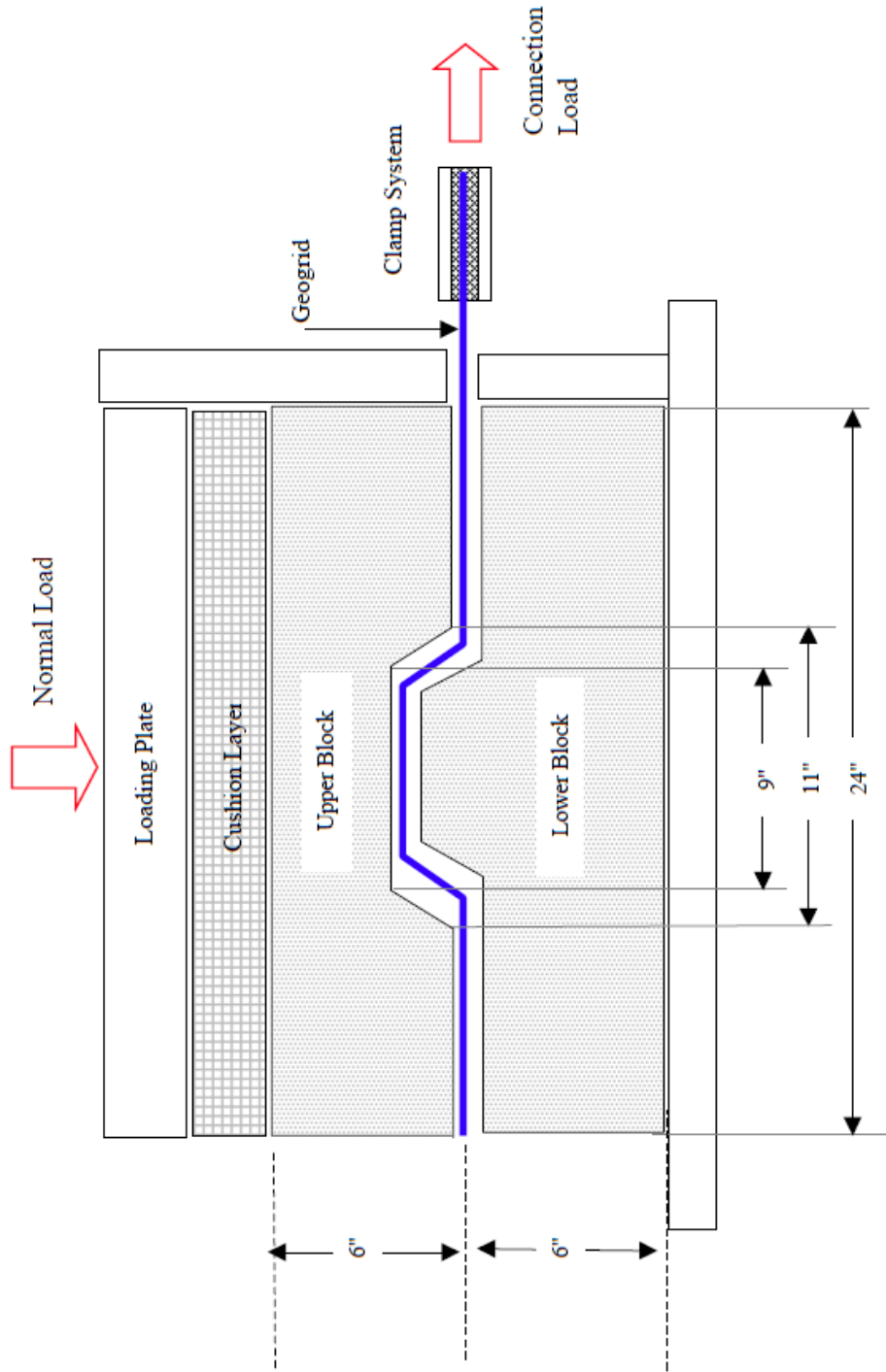

(NOTE: Not to Scale)

DATE: 5/7/2019

FIGURE NO. A-1

PROJECT NO. SGI19029

DOCUMENT NO.

FILE NO.



SGI TESTING SERVICES, LLC

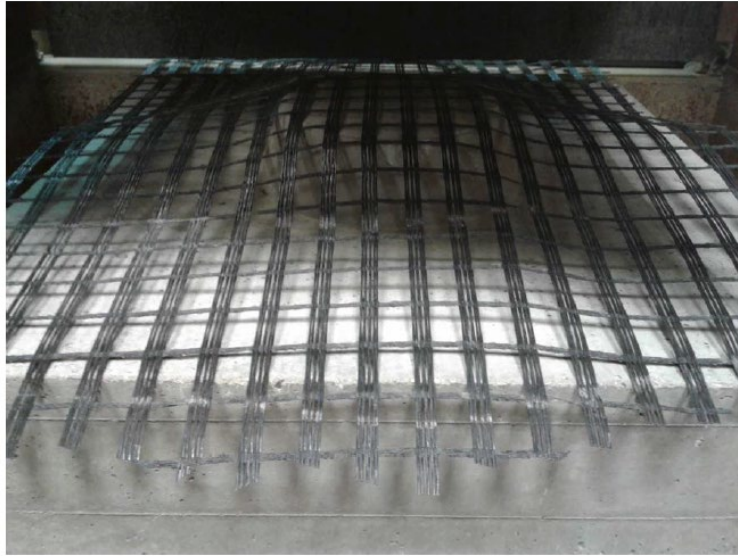

Figure A-2. SRW-7 geogrid placed on top of the Landscape lower block.



Figure A-3. Front view of the connection test setup.



Figure A-4. Abrasion and rupture of geogrid ribs at the completion of a test.

**SRW PRODUCTS
CONNECTION STRENGTH TESTING (ASTM D 6638)**

TEST SERIES NO. 1: SRW-7 geogrid in machine direction between two courses of Landscape blocks without AASHTO #57 stone

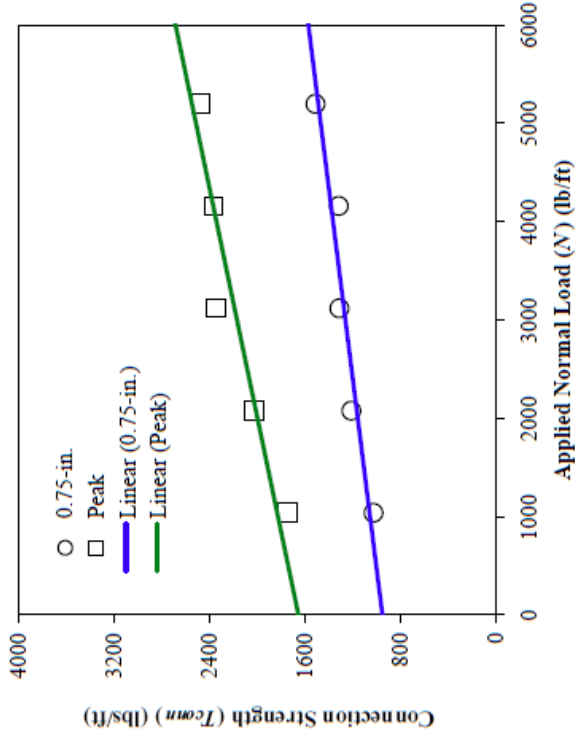
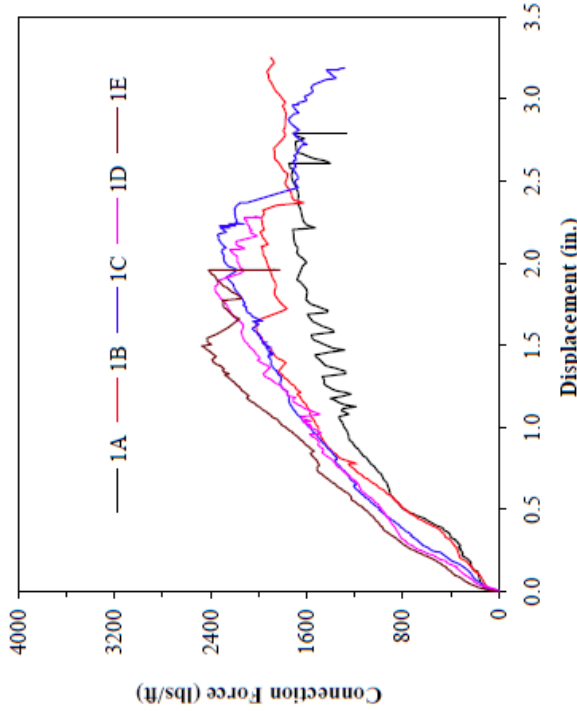

Test No.	Geogrid Specimen Width W (in.)	Test Normal Stress σ_n (psi)	Equivalent Normal Load N (lb/ft)	Approximate No. of Blocks n (-)	Approximate Wall Height h (ft)	0.75-in. Strength $T_{0.75-in}$ (lb/ft)	Peak Strength T_{peak} (lb/ft)	Connection Strength Equations (Strength assumed to be linearly related to N)
1A	23.0	3.6	1040			1026	1749	$T_{0.75-in} = 950 + (N) \tan (6^\circ)$ $T_{peak} = 1655 + (N) \tan (10^\circ)$
1B	23.0	7.2	2080			1211	2024	
1C	23.0	10.8	3120			1311	2342	
1D	23.0	14.4	4160			1317	2363	
1E	23.0	18.1	5200			1511	2472	

NOTES:
 Dimensions of Block: 24" wide by 24" long and 6" high.
 Weight of Full-Size Block: .
 Approximate Unit Weight of Facing (Block):
 Failure Mode: Abrasion and/or rupture of geogrid ribs against the knob of blocks in each test.

DATE REPORTED: 5/8/2019
 FIGURE NO. B-1
 PROJECT NO. SGI18017
 DOCUMENT NO.
 FILE NO.



SGI TESTING SERVICES, LLC

**SRW PRODUCTS
CONNECTION STRENGTH TESTING (ASTM D 6638)**

TEST SERIES NO. 2: SRW-9 geogrid in machine direction between two courses of Landscape blocks without AASHTO #57 stone

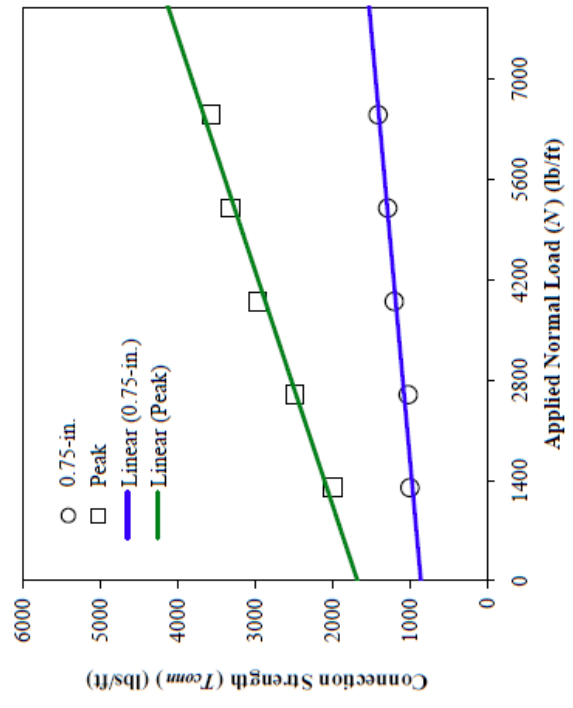
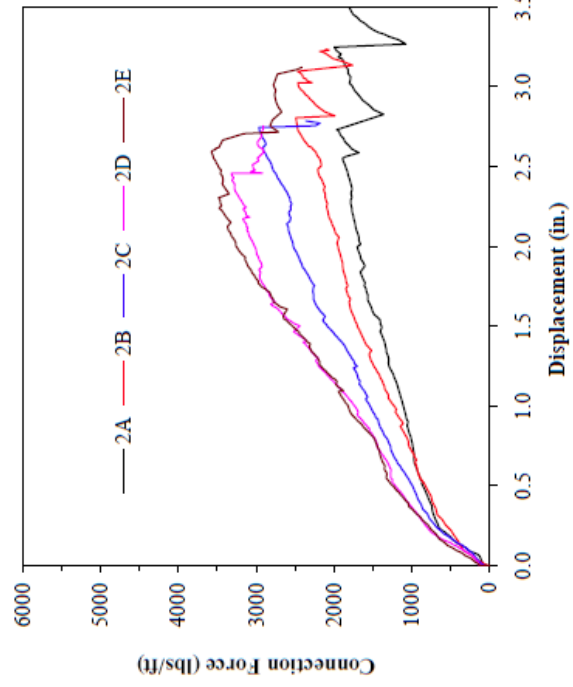

Test No.	Geogrid Specimen Width W (in.)	Test Normal Stress σ_n (psi)	Equivalent Normal Load N (lb/ft)	Approximate No. of Blocks n (-)	Approximate Wall Height h (ft)	0.75-in. Strength $J_{0.75-in}$ (lb/ft)	Peak Strength J_{peak} (lb/ft)	Connection Strength Equations (Strength assumed to be linearly related to N)
2A	23.0	4.5	1300			1002	2000	$T_{0.75-in.} = 860 + (N) \tan (5^\circ)$ $T_{peak} = 1680 + (N) \tan (17^\circ)$
2B	23.0	9.0	2600			1021	2490	
2C	23.0	13.5	3900			1202	2970	
2D	23.0	18.1	5200			1286	3320	
2E	23.0	22.6	6500			1412	3570	

NOTES:
 Dimensions of Block: 24" wide by 24" long and 6" high.
 Weight of Full-Size Block:
 Approximate Unit Weight of Facing (Block):
 Failure Mode: Abrasion and/or rupture of geogrid ribs against the knob of blocks in each test.

DATE REPORTED: 5/8/2019
 FIGURE NO. B-2
 PROJECT NO. SGI18017
 DOCUMENT NO.
 FILE NO.



**SRW PRODUCTS
CONNECTION STRENGTH TESTING (ASTM D 6638)**

TEST SERIES NO. 3: SRW-11 geogrid in machine direction between two courses of Landscape blocks without AASHTO #57 stone

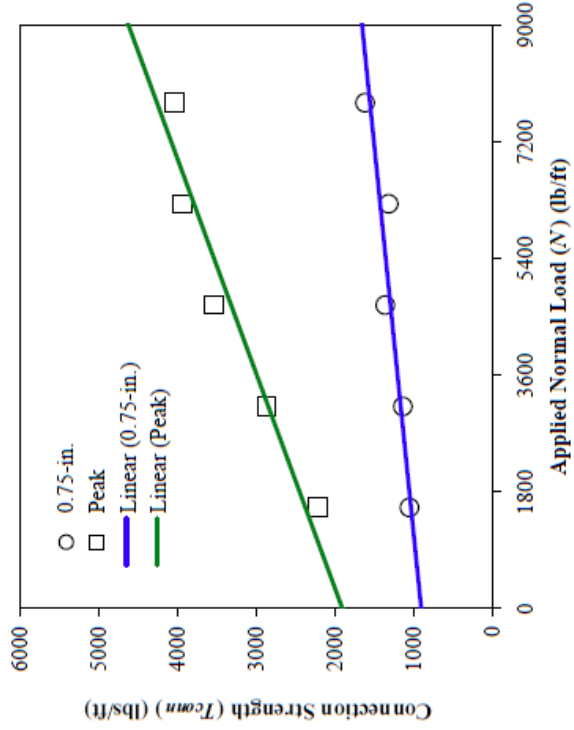
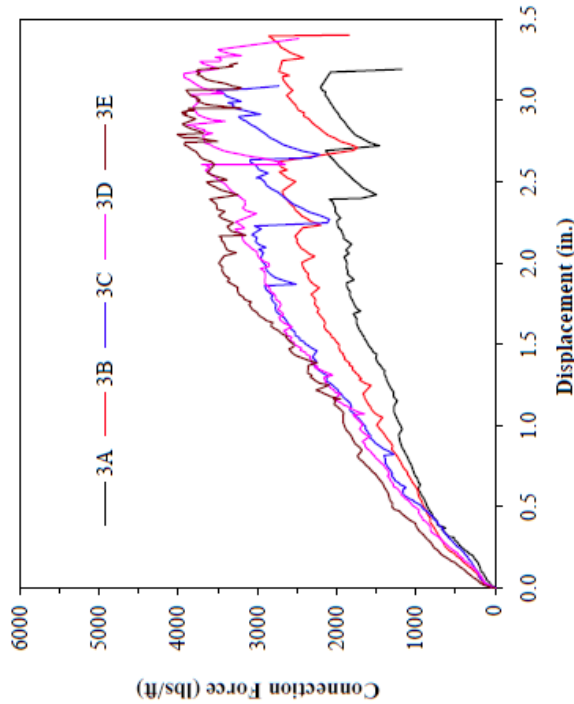

Test No.	Geogrid Specimen Width W (in.)	Test Normal Stress σ_n (psi)	Equivalent Normal Load N (lb/ft)	Approximate No. of Blocks n (-)	Approximate Wall Height h (ft)	0.75-in. Strength $T_{0.75-in}$ (lb/ft)	Peak Strength T_{peak} (lb/ft)	Connection Strength Equations (Strength assumed to be linearly related to N)
3A	23.0	5.4	1560			1054	2216	$T_{0.75-in.} = 905 + (N) \tan (5^\circ)$ $T_{peak} = 1905 + (N) \tan (17^\circ)$
3B	23.0	10.8	3120			1139	2870	
3C	23.0	16.3	4680			1363	3336	
3D	23.0	21.7	6240			1319	3940	
3E	23.0	27.1	7800			1617	4037	

NOTES:
Dimensions of Block:
Weight of Full-Size Block:
Approximate Unit Weight of Facing (Block):
Failure Mode:

24" wide by 24" long and 6" high.

Abrasion and/or rupture of geogrid ribs against the knob of blocks in each test.

DATE REPORTED: 5/8/2019
FIGURE NO. B-3
PROJECT NO. SGI18017
DOCUMENT NO.
FILE NO.



SGI TESTING SERVICES, LLC

PART “B”

INTERFACE SHEAR TESTING

INTRODUCTION

This report gives the results of an interface shear testing program carried out to evaluate the mechanical/frictional performance of the shear connection between World Block Landscape Block segmental concrete block units.

The test program was initiated in response to a verbal authorization to proceed from Mr. Rod Johnson of World Block received 25 September 2007.

The tests were carried out at the laboratories of Bathurst, Clarabut Geotechnical Testing, Inc. in Kingston, Ontario, under the supervision of Mr. Peter Clarabut.

OBJECTIVES OF TEST PROGRAM

The interface shear capacity between World Block Landscape Block concrete units stacked in a vertical configuration was investigated using a large-scale test apparatus.

The principal objective of the testing was to evaluate the mechanical/frictional performance of the shear connection between successive layers of World Block Landscape Block units. A second objective was to make recommendations for the selection of interface shear capacities to be used in the design and analysis of retaining wall systems that employ World Block Landscape Block units.

MATERIALS

World Block Landscape Blocks are solid concrete units weighing approximately 2400 pounds per unit. The nominal dimensions of the block are 24 inches wide (toe to heel) by 24 inches high by 48 inches long. Construction alignment and wall batter is achieved by means of two concrete shear keys cast into the top surface of the units. The installation

arrangement is illustrated in Figure 1. A photograph of the World Block Landscape Block units is shown in Figure 2. The blocks used in this series of tests were supplied by World Block and were received at our laboratory on 28 September 2007 and designated as BIC 07-036.

APPARATUS AND GENERAL TEST PROCEDURE

The SRWU-2 method of test as reported in the NCMA Segmental Retaining Wall Design Manual (1993) and ASTM D 6819 was used in this investigation. A brief description of the apparatus and test methodology is presented here. The apparatus used to perform the tests is illustrated in Figure 1. The test apparatus allows horizontal loads of up to 35,000 lbf to be applied across the interface between two block layers. The segmental units were laterally restrained at the bottom and surcharged vertically. A single block was stacked over the under lying blocks. Wall heights were simulated by placing a single block over the interface and applying additional normal load using the air bag arrangement shown in Figure 1. The horizontal (shear) force was applied at a constant rate of displacement using a computer-controlled hydraulic actuator. The load and displacements measured by the actuator and displacement transducers were recorded continuously during the test by a microcomputer/data acquisition system. Each test was continued until large shear displacements or the client specified shear capacity of 3500lb/ft was achieved. Following each test, the blocks were removed and the units examined to confirm failure modes (if applicable).

The only variable in this series of interface shear tests was the magnitude of surcharge (i.e. the magnitude of normal load applied to the top segmental unit). The normal loads used in the test program are given in Table 1.

TEST RESULTS

Results of interface shear tests are summarized in Table 1. Peak interface shear capacities are plotted against normal load in Figure 3. The displacement criterion was calculated to be 0.48 inch based on 2% of the block height. The minimum peak shear capacity recorded from the test series was 2756 lb/ft. In Test 8, the upper block slid over the shear keys of the lower block units. All other tests were terminated prior to failure when the client specified shear capacity had been achieved.

IMPLICATIONS TO INTERFACE SHEAR CAPACITY DESIGN AND CONSTRUCTION WITH WORLD BLOCK LANDSCAPE BLOCK UNITS

The maximum shear capacity values reported herein are conservative estimates of the peak shear capacity of the World Block Landscape Block system because the tests were terminated prior to failure (except Test 1). Hence, the use of the maximum shear capacity values reported herein will result in an unquantified additional margin of safety for the nominal identical system in the field. The NCMA Segmental Retaining Wall Design Manual (First Edition, 1993) recommends that the design shear capacity at a given normal load for a critical wall structure be the lesser of: a) the peak capacity divided by a minimum factor of safety (not less than 1.5) or; b) the capacity based on the 0.48 inch displacement criterion. Nevertheless, the design shear capacity envelope inferred from the test data reported herein should be used with caution. The actual design capacity envelope should be lower if the quality of construction in the field is less than that adopted in this controlled laboratory investigation and/or lower quality concrete is used in the manufacture of the blocks. In addition, the interface concrete surfaces should be free of aggregate particles in order to maximize

the frictional resistance that is developed between the concrete surfaces. The design interface shear capacity envelope shown in Figure 4 is controlled by the peak shear (assumed) criterion.

SUMMARY OF CONCLUSIONS

A laboratory testing program was carried out to evaluate the mechanical/frictional performance of the shear connection between World Block Landscape Block segmental concrete units. The actual peak shear capacity of the World Block Landscape Block system may be expected to be greater than the values reported herein since the tests were terminated before shear failure of the blocks could be achieved.

CONCLUDING REMARKS

The test results presented here are applicable to both gravity and geosynthetic reinforced soil segmental retaining wall designs that employ World Block Landscape Block units. However, the inclusion of a layer of geosynthetic reinforcement between the courses may reduce the interface shear capacity to values less than those reported in this investigation.



P. Clarabut

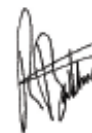

R. J. Bathurst, Ph.D., P. Eng.

REFERENCES

- ASTM D6916-03. Standard Test Method for Determining Shear Strength between Segmental Concrete Units (Modular Concrete Blocks), American Society for Testing and Materials, West Conshohocken, PA 19428-2958 USA.
- Simac, M.R., Bathurst, R.J., Berg, R.R. and Lothspeich 1993. NCMA Segmental Retaining Wall Design Manual (First Edition, 1993), National Concrete Masonry Association, 2302 Horse Pen Road, Herndon, VA 22071-3406, 250 p.

TABLE 1:
 Test Program:
 World Block Landscape Block unit interface shear testing

Test number	approximate wall height (feet)	approximate number of blocks	normal load (lb/ft)	shear capacity (lb/ft) at 0.48 inch displacement	peak shear capacity (lb/ft)
1	16.6	8.3	5006	3668	3668
2	14.2	7.1	4303	3668	3668
3	11.5	5.7	3448	3673	3673
4	8.6	4.3	2576	3690	3690
5	8.7	4.3	2616	3668	3668
6	8.7	4.3	2604	3679	3679
7	5.9	2.9	1761	3656	3656
8	3.2	1.6	956	2756	2756

FIGURE 1:

Schematic of shear capacity test apparatus showing World Block Landscape Block segmental concrete units

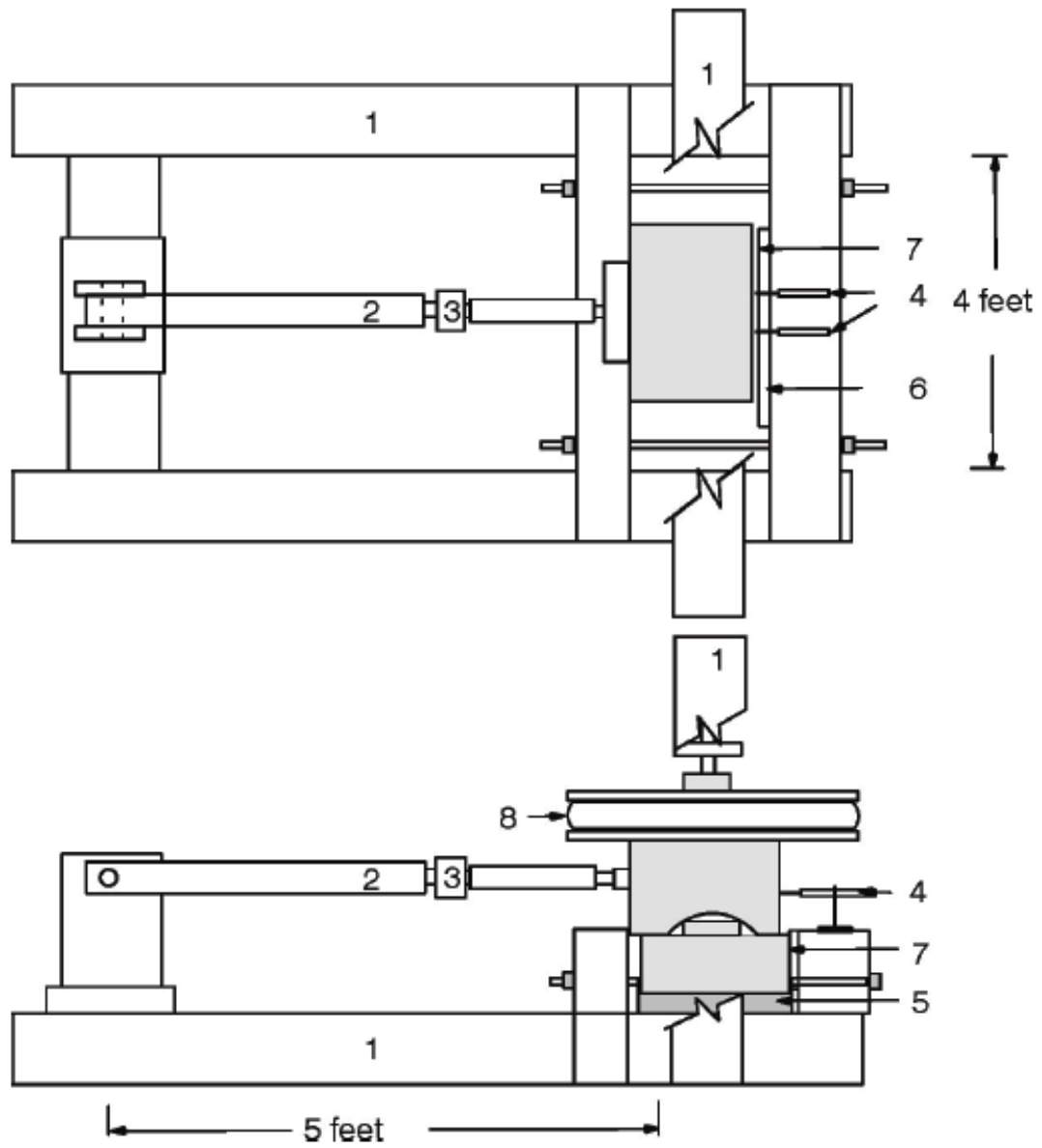

- | | |
|------------------------|----------------------------|
| 1 loading frame | 2 horizontal actuator |
| 3 horizontal load cell | 4 displacement transducers |
| 5 platform | 6 spacers |
| 7 Landscape Block | 8 air bag load arrangement |

FIGURE 2:

Photograph of the World Block Landscape Block configuration used in the shear test apparatus



FIGURE 3:
Interface shear versus normal load for World Block Landscape Block tests

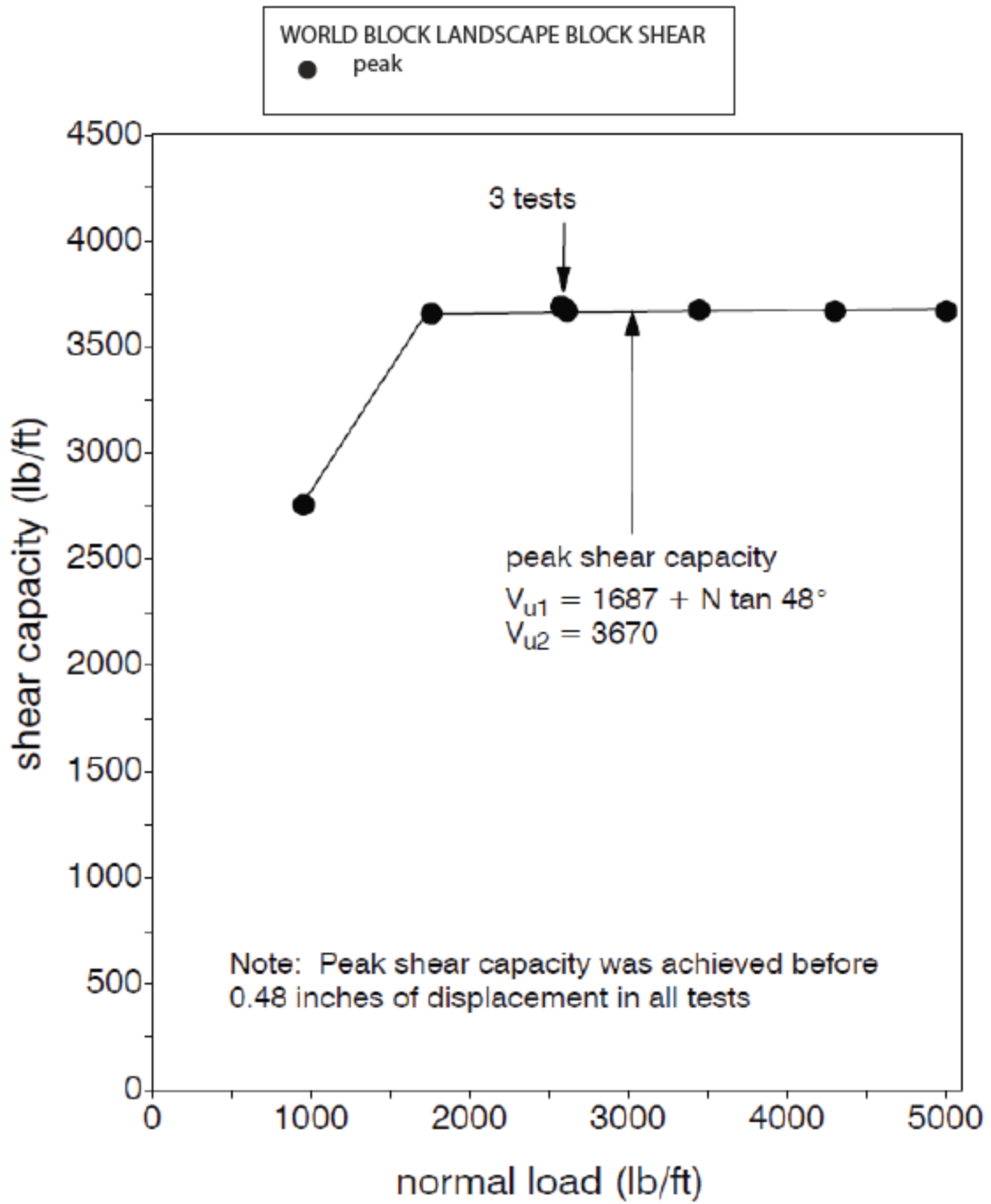

FIGURE 4:
Preliminary design curve for shear capacity versus normal load for World Block Landscape Blocks

